



Insight Operation Manual

Introduction

The Greer Insight system is designed for use as an aid to crane operation.

Do not use this system without a properly trained operator who is knowledgeable in safety guidelines, crane capacity information, and the crane manufacturer's specifications.

This manual describes the operation of the Greer Insight, hereinafter referred to as the system. Please read the contents and instructions contained

Table of Contents

Outline of Operation.....	4
System Components.....	4
Power-Up Self-Test	6
Home Display	6
The Configuration Display.....	7
Home Button.....	8
Outrigger/Tire Selection	8
Parts of Line.....	8
Jib Options.....	9
Pick.....	9
Stow (Stowed Jib).....	9
Winch.....	10
Operator Alarms.....	10
The Home Display	11
Outrigger/Tires.....	11
Actual Load.....	12
Cancel Alarm Button	12
Parts of Line.....	12
Information.....	13
Rated Capacity	13
Calibration Button	13
Erected Jib.....	14
System.....	14
Anti-Two-Block.....	14
Jib Stowed	15
Boom Length Display	15
Pick Point.....	15
Configuration Button	16
Boom Length Symbol.....	16
Boom Angle Symbol	16
Load Radius Symbol.....	17
Swing Button.....	17
Load Radius Display	17
Swing Display	18
Boom Angle Display.....	18
Bar Graph	18

Cancel Alarm Button.....	19
Reset Function Kickout	19
Operator Programmable Alarms	20
Setting the Operator Alarms.....	20
Setting the Minimum/Maximum Boom Angle Alarms.....	21
Setting the Maximum Boom Length/Tip Height Alarms	22

Outline of Operation

The system is an aid to crane operation. Crane functions are monitored by a variety of sensors.

The system compares the load suspended below the boom head to the crane capacity chart stored within the computer's memory.

At approach to overload, the system sends audible and visual warning signals. The system can be configured to cause function kick-out by sending a signal to function disconnect solenoids.

System Components

- Display Unit
- Computer Unit
- Pressure Sensors
- Reeling Drum Assembly, with Extension and Angle Sensors
- Anti-Two-Block Switches
- Cables
- Audible Alarm
- Installation/Operator Manuals

Display Unit

The display unit provides the operator with:

- Rated Capacity
- Actual Load
- Bar graph representation of Actual Load vs. Rated Capacity
- Radius of the Load
- Boom Angle
- Main Boom Length
- Working Area
- Crane Configuration

BOOM ANGLE SENSOR

The boom angle is measured by a potentiometer/pendulum assembly. It provides a voltage proportional to boom angle. This sensor is mounted inside the cable reeling drum assembly.

EXTENSION SENSOR

The extension sensor provides a voltage proportional to the extension of the boom. The extension sensor is mounted inside the cable reeling drum assembly.

PRESSURE SENSORS

There are two pressure sensors which measure pressure in the boom hoist cylinder. One sensor measures the rod-side pressure and one sensor measures the piston-side pressure.

ANTI-TWO-BLOCK (ATB)

A switch monitors the approach of the hookblock or overhaul ball to the boom head. The switch is held in the normal position until the hookblock or overhaul ball raises a weight that is mounted around the hoist rope. When the weight is raised it opens the switch. The resultant switch open signal is sent to the computer via the reeling drum. This results in the ATB alarm operating and a function kick-out to occur.

FUNCTION KICK-OUT

Electrically-operated hydraulic solenoids disconnect the control lever functions for boom hoist lower, telescope out, and winch up when an overload or ATB alarm condition occurs.

OPERATOR PROGRAMMABLE ALARMS

These alarms, when properly set by the operator, define the operating area. These alarms are programmable for each job site and allow the operator to work in a defined area.

- Minimum Boom Angle Alarm
- Maximum Boom Angle Alarm
- Maximum Boom Length Alarm
- Maximum Tip Height Alarm

Power Up Self-Test

Immediately following system power up, the system executes a system self-test which lasts for approximately 10 seconds. During this time the display shows the load chart number and units in use. During this time, crane motions are disabled by the system function kick-out.

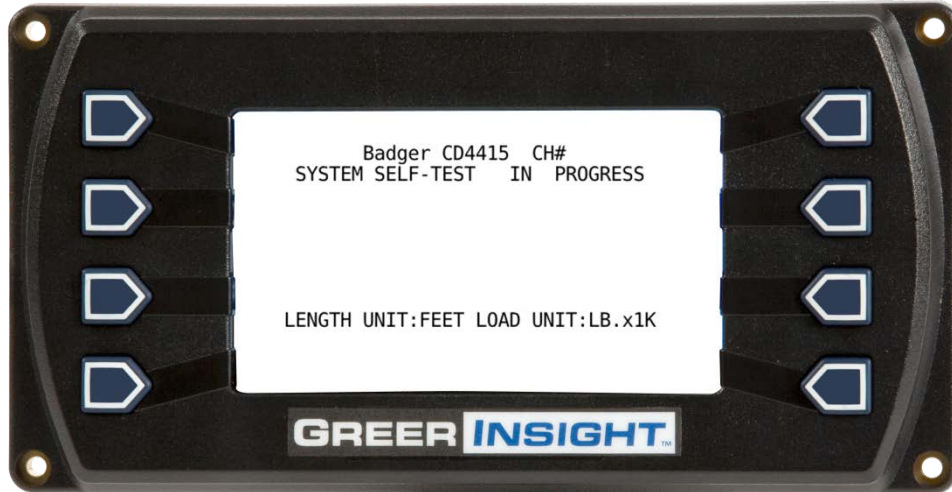

After the load chart screen, the display will automatically go to the home display.

Home Display



It will be necessary to ensure the machine is correctly configured. Press the configuration button to access the configuration display from the home display.

The Configuration Display

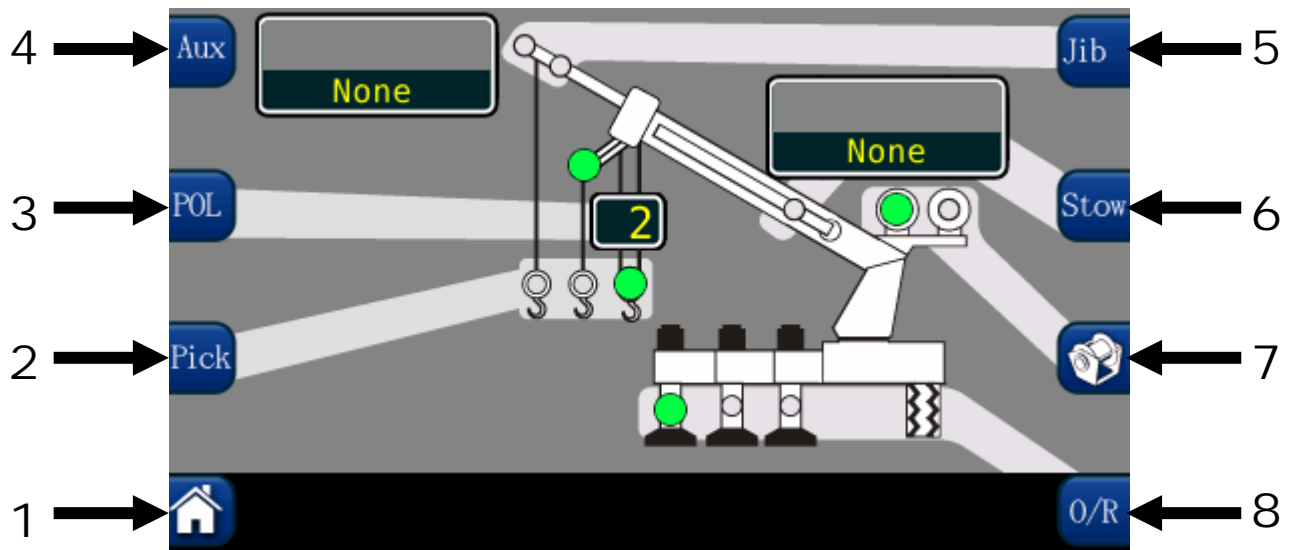

NOTE: The graphic above is only a representation of the system. The shaded areas may vary in configuration depending on the application.

NOTE: Always check the point of lift and parts of line upon selection of the winch.

The configuration display gives a pictorial representation of the current system setup. Each shaded area contains one or more green indicators and a button to change the setup selection. In groups with multiple options, green indicators illuminate individually to indicate the selection. When the configuration is complete, press the home button to return to the main operation screen.

WARNING!!

THE DISPLAYED LOAD AND CAPACITY ARE BASED UPON THE CURRENT SELECTED POINT OF LIFT. NEITHER THE GREER INSIGHT SYSTEM, NOR THE CRANE CAPACITY CHART ALLOWS FOR LIFTING FROM MORE THAN ONE PICK POINT AT A TIME.

1. The **HOME** button will return the user to the Home display.

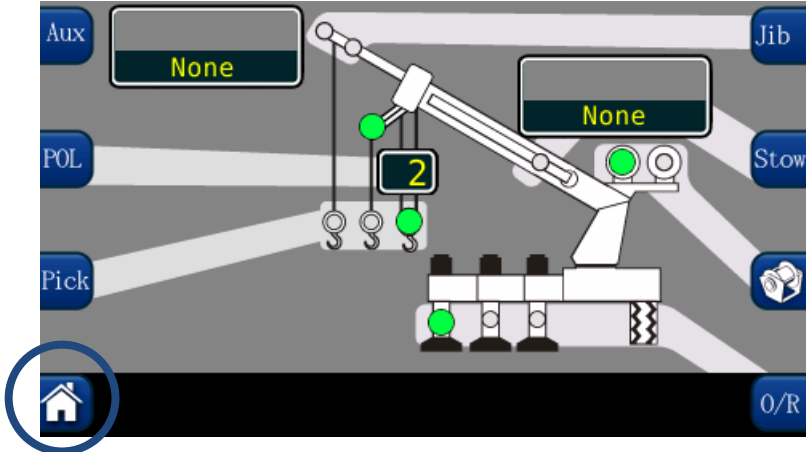

2. The **PICK** button contains three green indicators. A single green indicator will illuminate to show the point of lift. Press the "Pick" button to scroll through the available options.

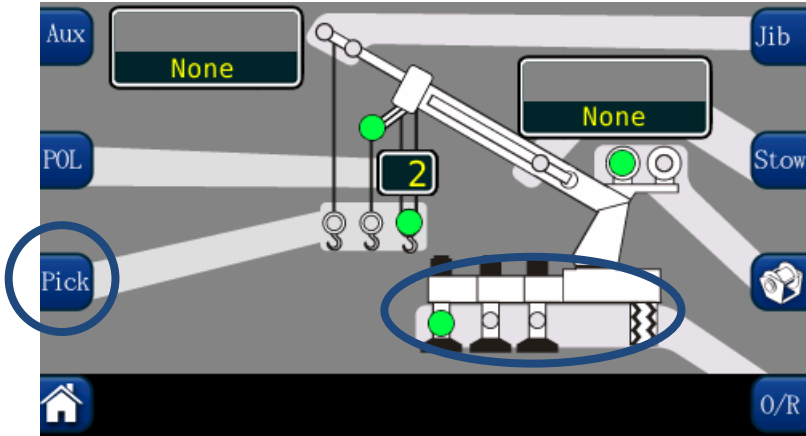

3. The **(POL)** button selects the current parts of line. Pressing the **POL** button will increment the **POL**. When the maximum is reached, the indicator will rollover to one **POL**.

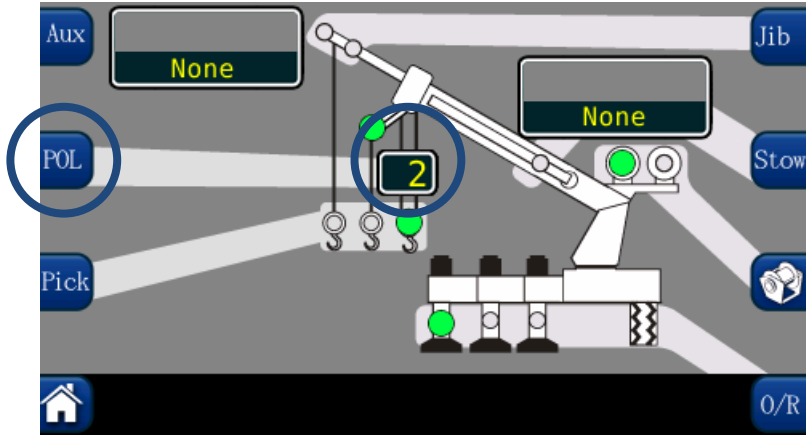

4. The **AUX HEAD** contains one green indicator that will illuminate when the aux head is fitted.

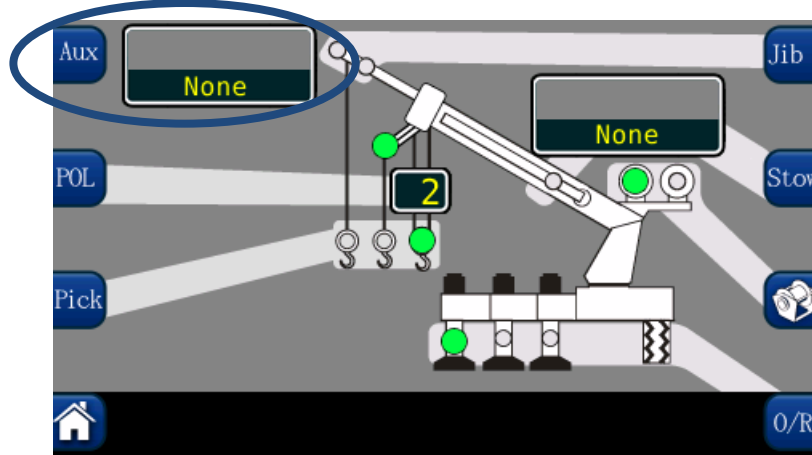

5. The **JIB OPTIONS** may be selected by pressing the jib button multiple times to scroll through the jib options. If a jib is not selected, or not available, the display will show “None”.

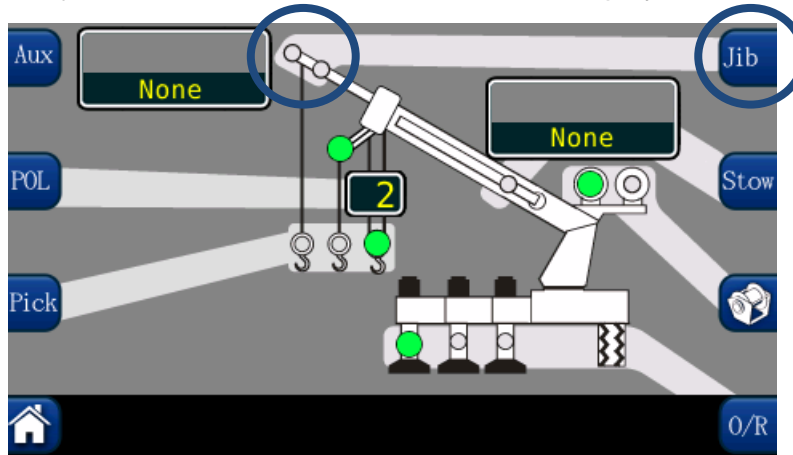

6. The **STOW (STOWED JIB)**, group contains one green indicator. This will illuminate when a jib is stowed on the boom. Each button press will scroll through the available jib options. If there are no options available, or none are selected, the display will show “None”.

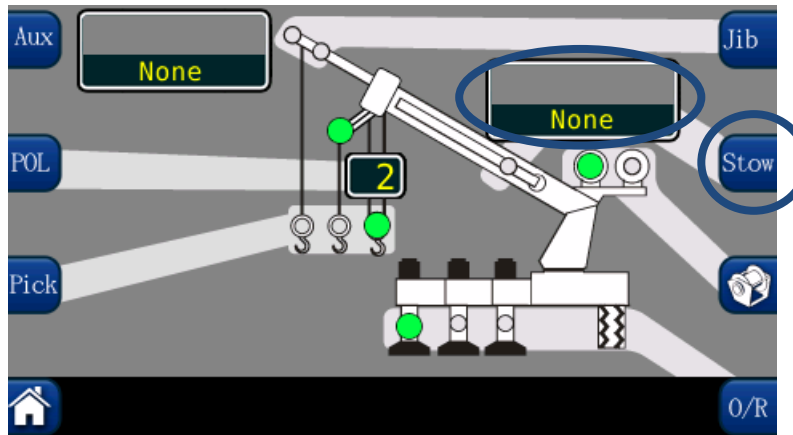

7. The **WINCH** group contains two green indicators, which indicate the selection of front or rear winch. *NOTE: If the crane is equipped with two winches, always select the winch to be used for the lift, prior to selecting the parts of line selections for each winch.*

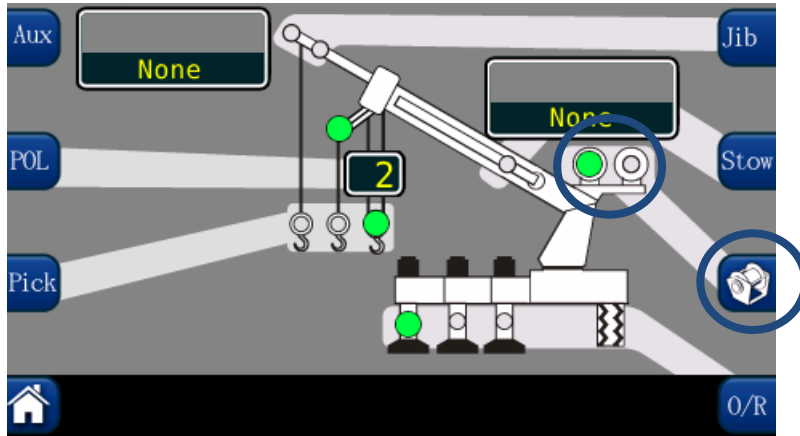

8. The **OUTRIGGER/TIRE** selections are made by pressing the button circled. Each button press will scroll to the next available options. *NOTE: Some cranes will not have the option of selecting different outrigger positions.*

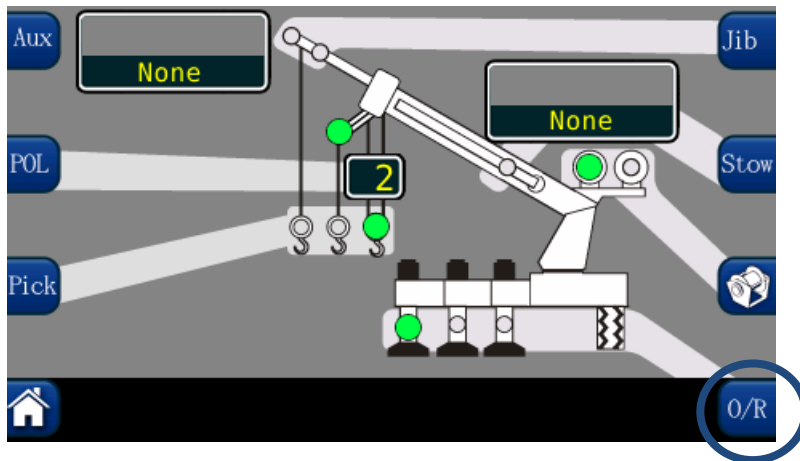

The Home Display

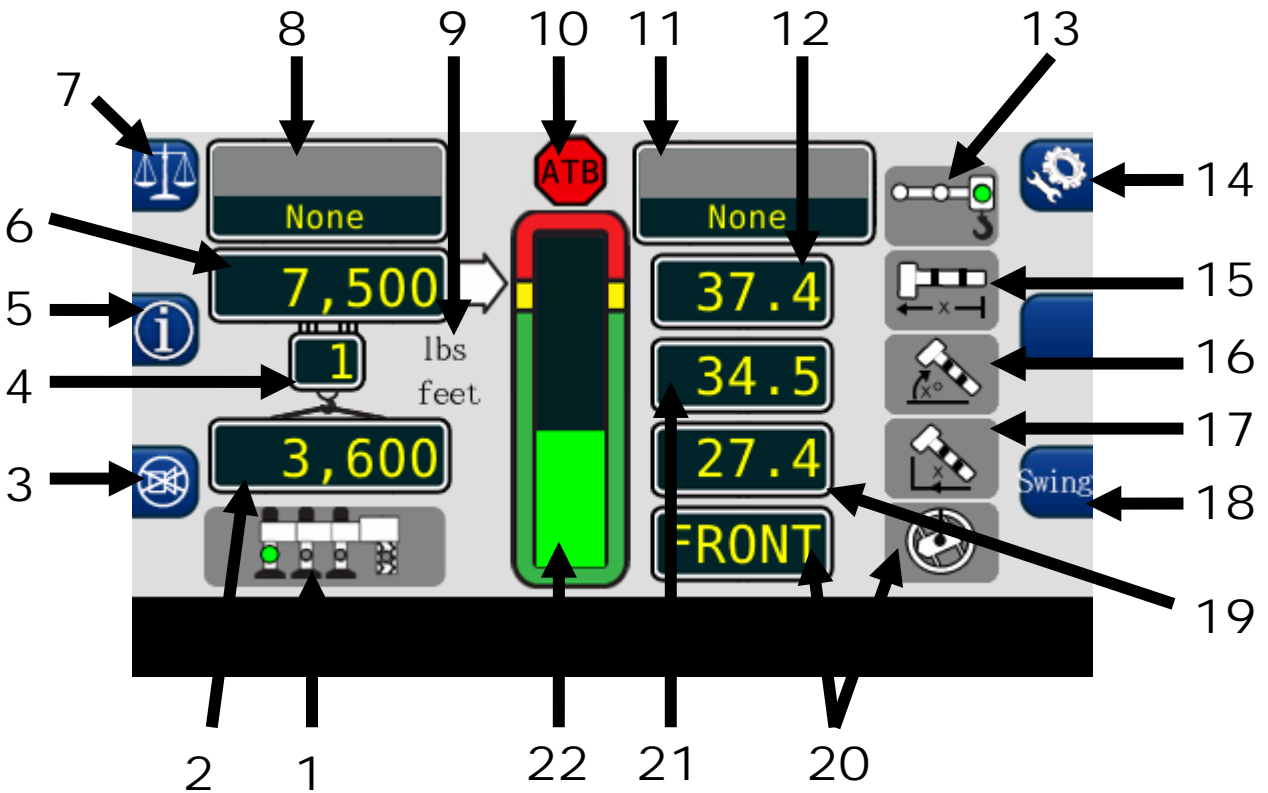

1. The **OUTRIGGER/TIRES** setting contains four green indicators. They indicate the selection of tires, full, intermediate, or retracted outriggers. The user must make the selection from the configuration display. *NOTE: OUTRIGGER/TIRE selections are dependent on the crane being used.*

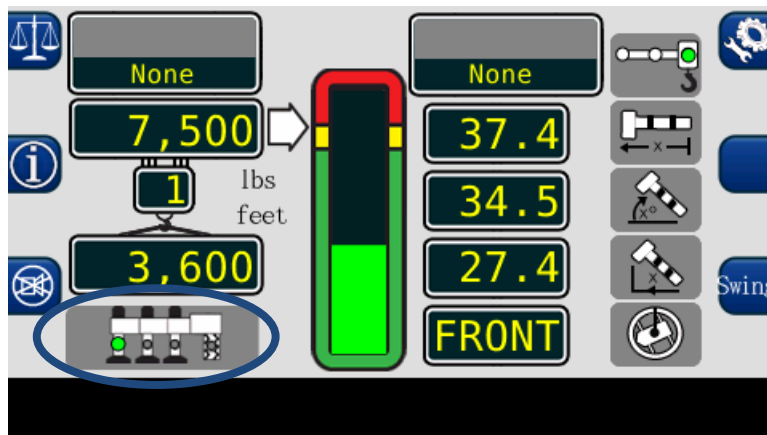

2. The **ACTUAL LOAD** value displays the total load, including slings, etc., suspended below the lifting point.

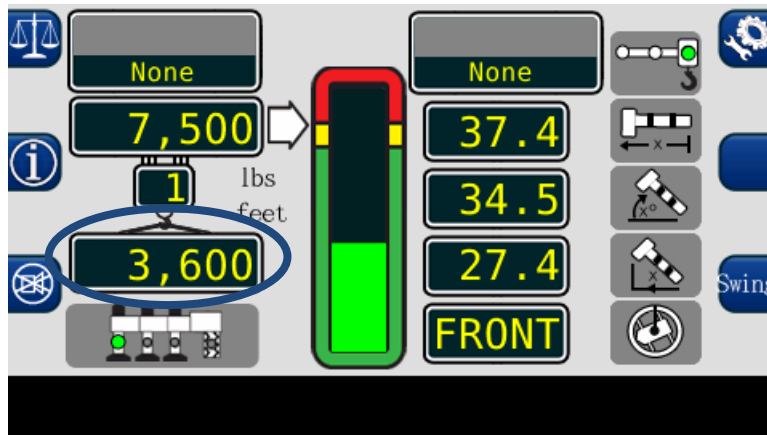

3. The **CANCEL ALARM BUTTON** is used to silence the audible alarm generated by an overload, ATB Alarm, operator programmable alarm, or outrigger position mismatch. The audible alarm remains cancelled until the condition causing the alarm has been resolved.

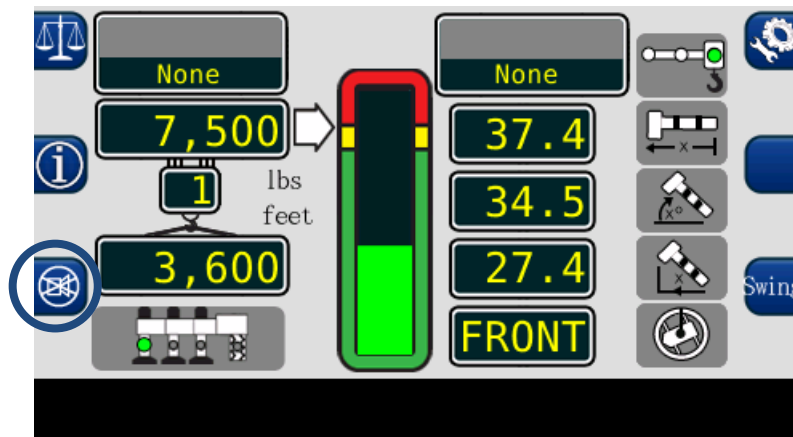

4. The **PARTS OF LINE** display shows the amount of line chosen for the configuration selected. It is adjustable from the configuration screen.

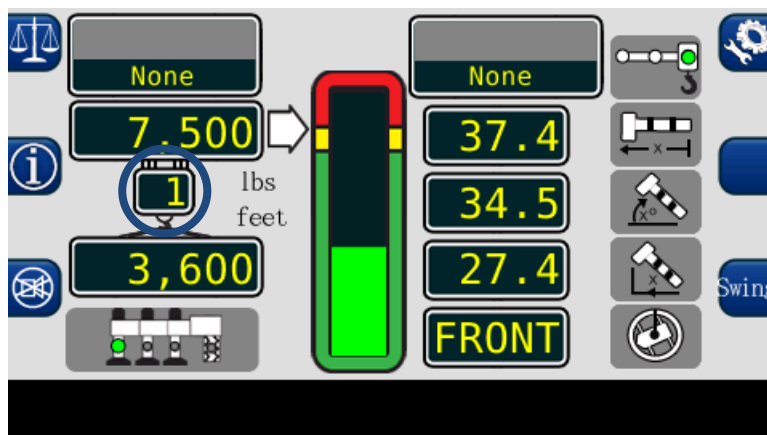

5. The **INFORMATION** button displays system generated messages regarding the software versions of the equipment and fault codes. When the information button is pressed, the data is displayed as long as the button is held. Some faults do not generate fault codes. For more information on fault codes, refer to manual W450351.

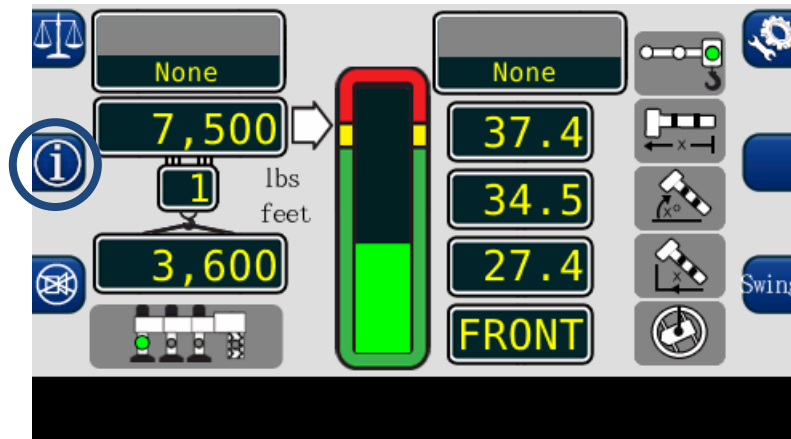

6. The **RATED CAPACITY** display shows the maximum rated capacity in the current configuration.

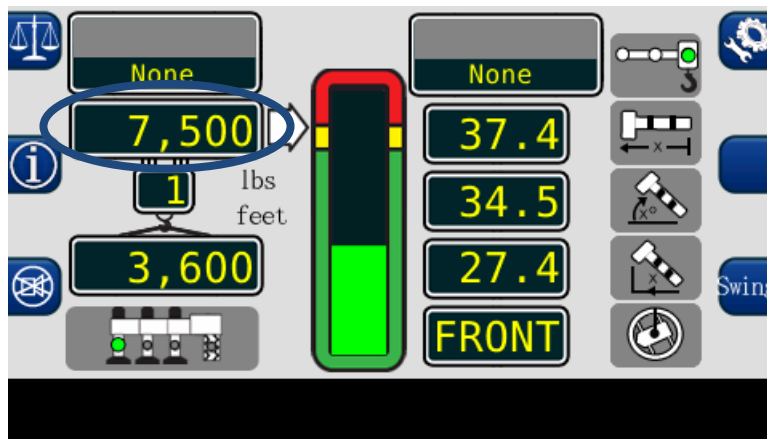

7. The **CALIBRATION** BUTTON accesses the calibration menu.

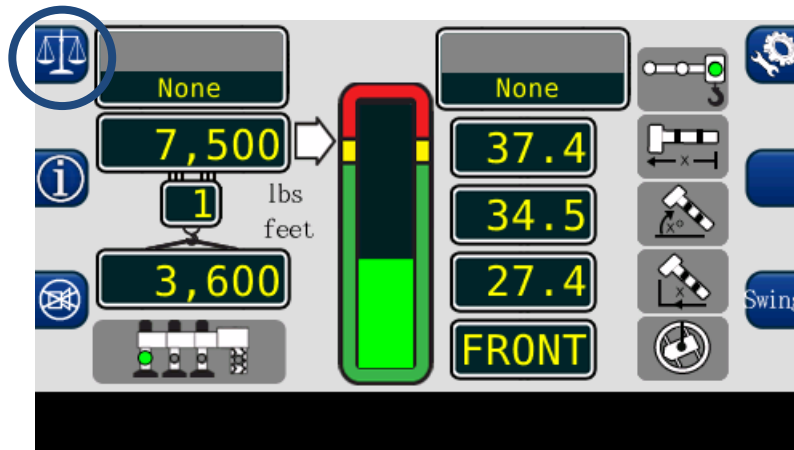

8. The **ERECTED JIB** display shows the jib option selected for the machine. If there are no jib options available, or one is not selected, the display will show “None”.

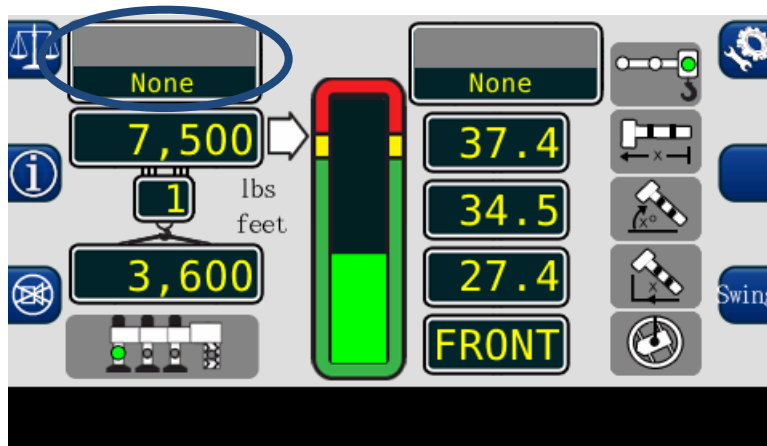

9. The **SYSTEM** has the capability of showing metric or imperial units.

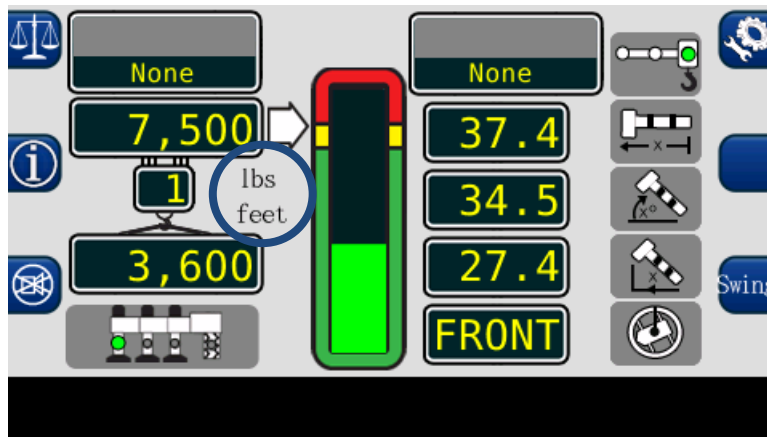

10. The **ANTI-TWO-BLOCK** indicator illuminates when the ATB Limit switch detects a two-block condition.

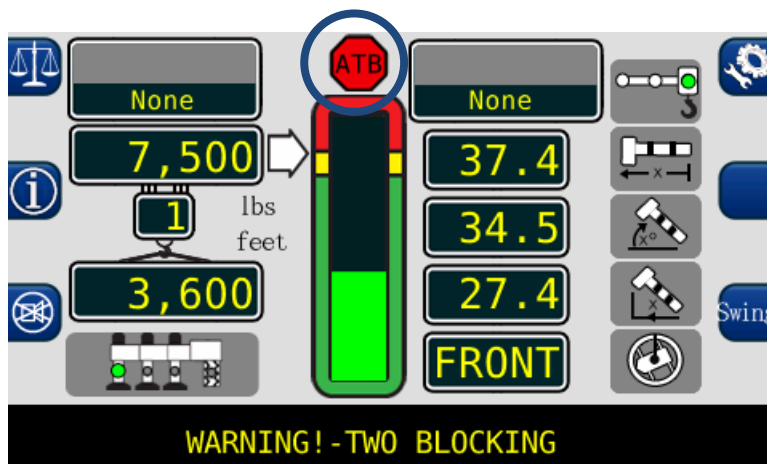

11. The **JIB STOWED** display shows the stowed jib from the configuration screen. The length and offset of the jib in use is also shown in the home display.

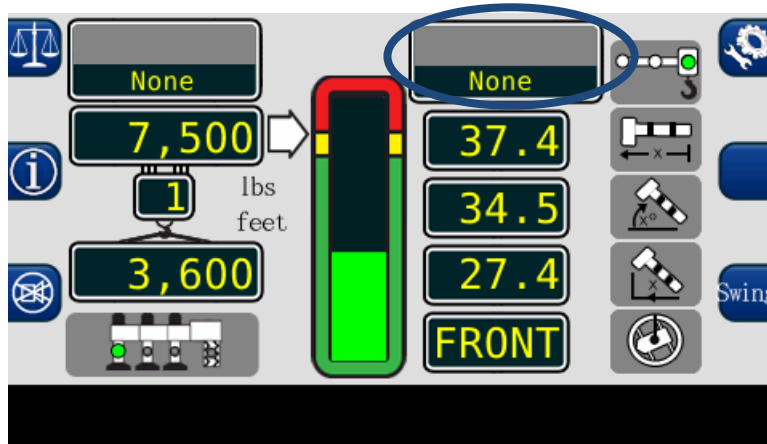

12. The **BOOM LENGTH** display shows the length of the main boom from the boom foot pin to the sheave pin of the main boom head.

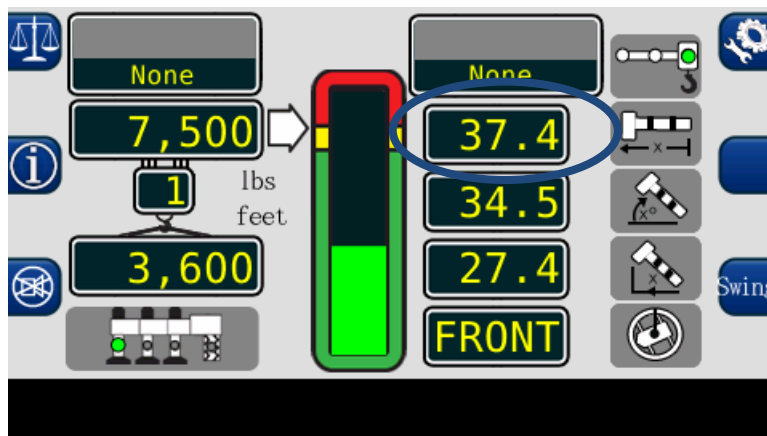

13. The **PICK POINT** selection is made from the configuration display screen. It changes automatically when the operator selects a jib.

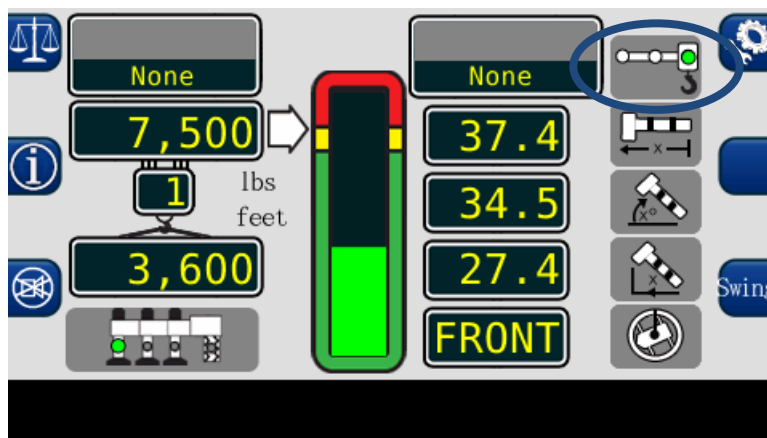

14. Press the **CONFIGURATION BUTTON** to return to the configuration display screen.

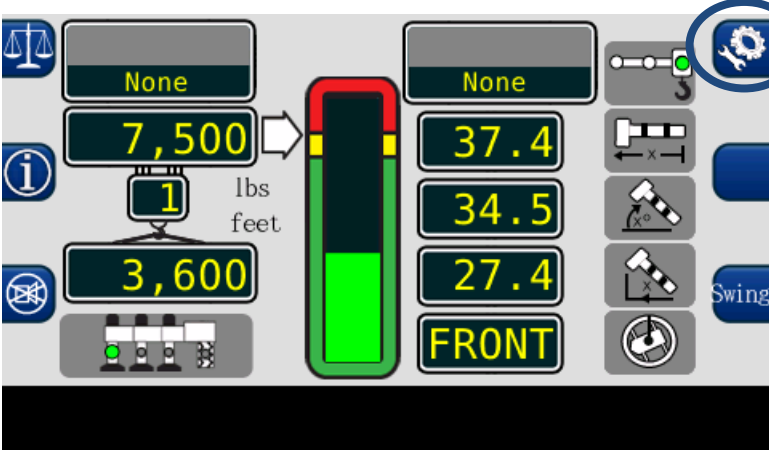

15. The **BOOM LENGTH** symbol is shown to the right of the boom length display.

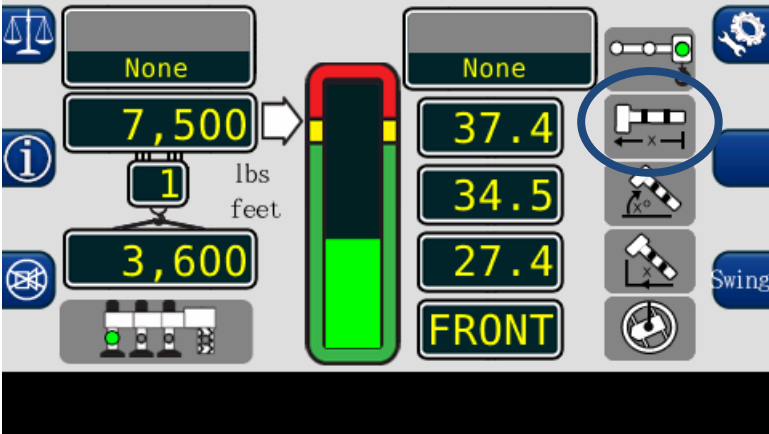

16. The **BOOM ANGLE** symbol is shown to the right of the boom angle display.

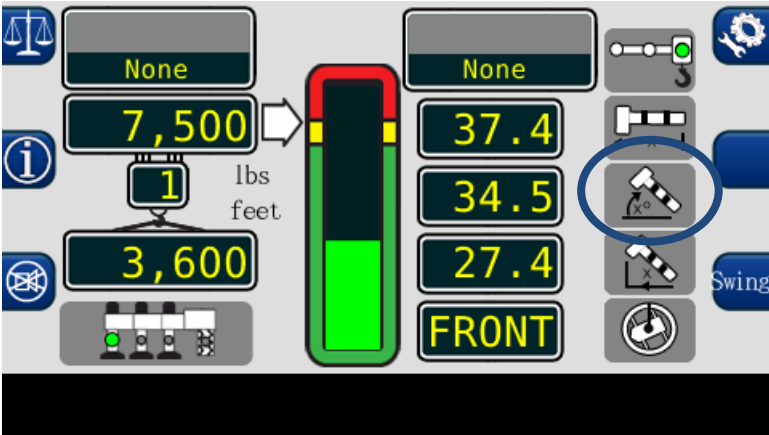

17. The **LOAD RADIUS** symbol is shown to the right of the load radius display.

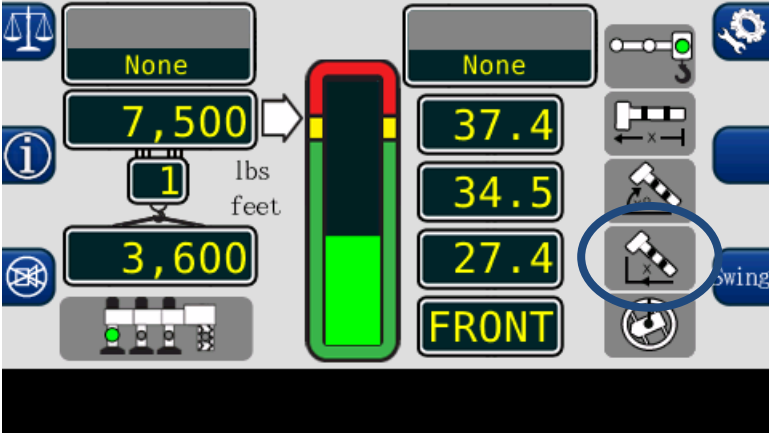

18. The **SWING** button allows the user to switch between the available load charts for the machine.

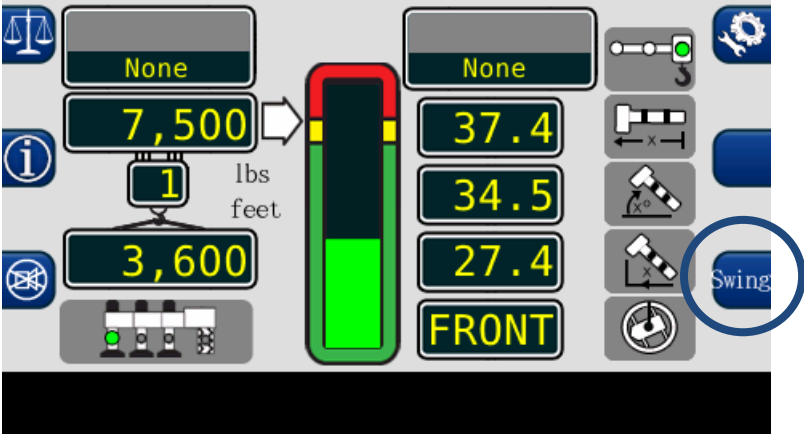

19. The **LOAD RADIUS** display is shown to the left of the load radius symbol.

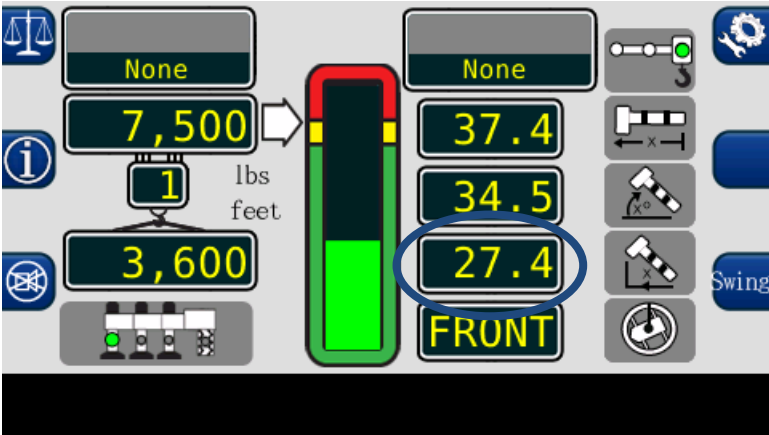

20. The **SWING** display indicates the currently selected load chart.

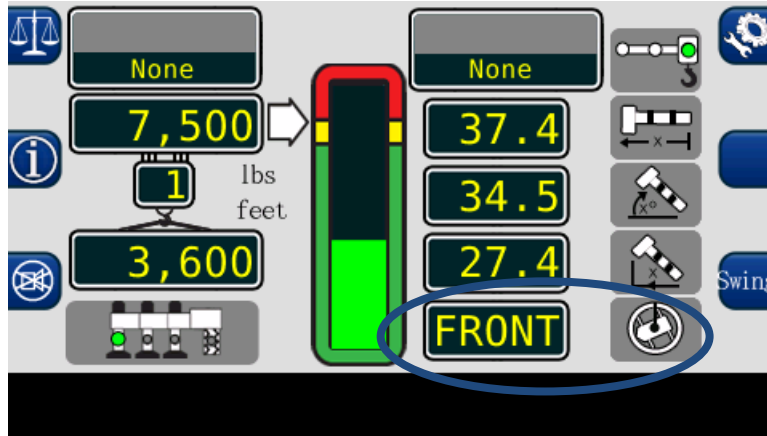

21. The **BOOM ANGLE** display indicates in degrees, the angle of the main boom relative to horizontal.

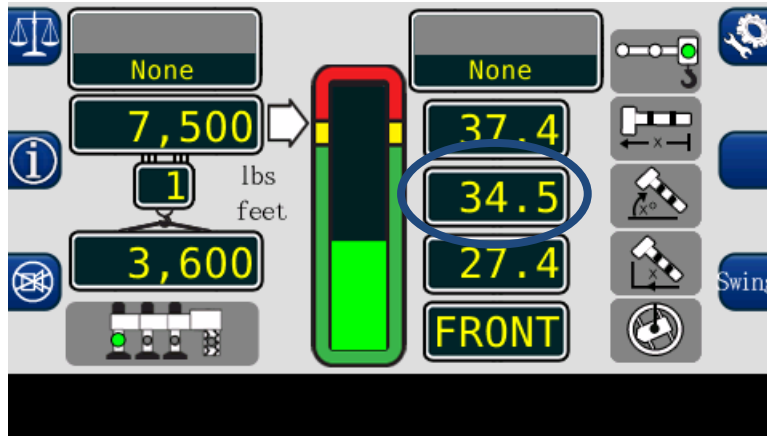

22. The **BAR GRAPH** indicates the actual load relative to the maximum rated capacity of the equipment in the current configuration.

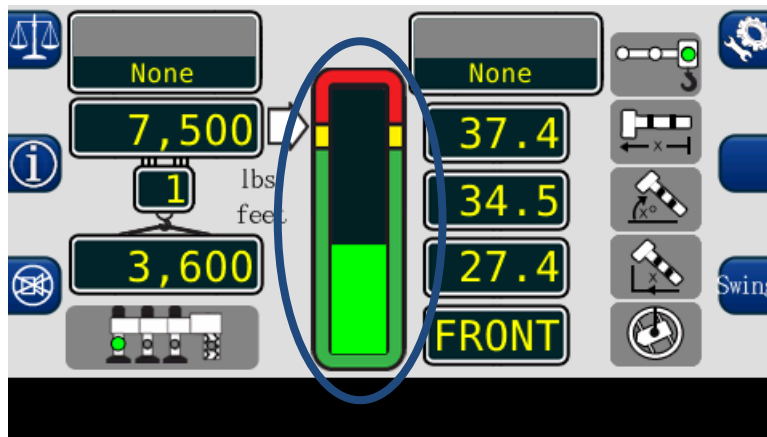

Choosing the Swing Area

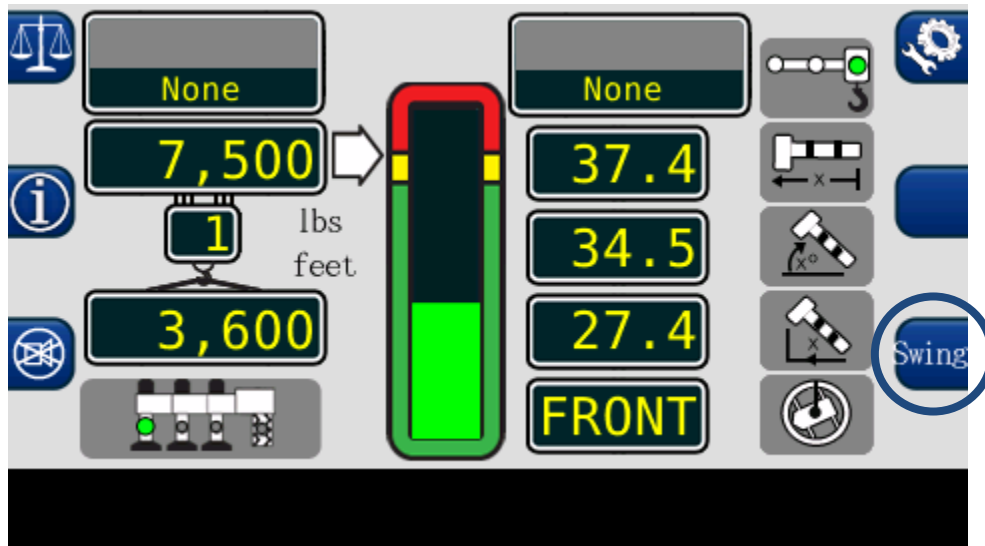

There are 3 different “Swing” selections for the machine:

- FRONT
- 360
- F-ARC

Choose the “Swing” area based on the current configuration of the machine.

FRONT: Use with the outriggers fully extended and the load to remain within 20° of the machine centerline.

360: This chart allows the boom to rotate 360° while in use. There are two capacities with this Swing area. One capacity is for use on fully extended outriggers and one capacity is for use on tires. The operator can choose between outriggers and tires in the configuration menu.

F-ARC: This chart for is for pick-and-carry use with the boom centered over-front.

NOTE: Illustrations on the following page.

ON OUTRIGGERS

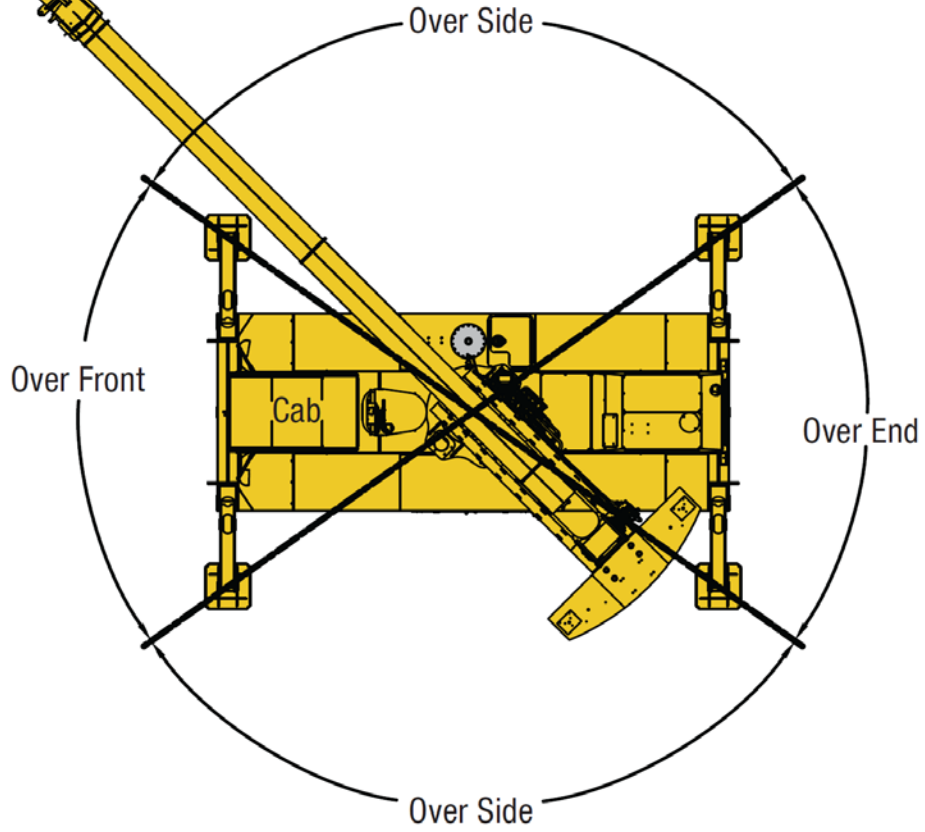

ON TIRES

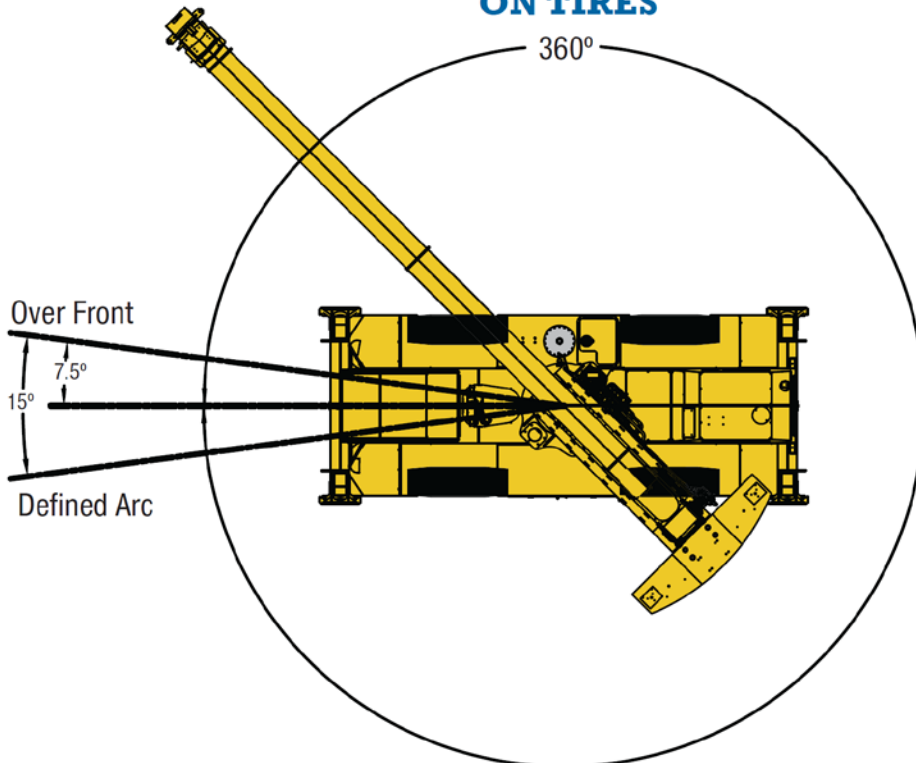

CANCEL ALARM BUTTON

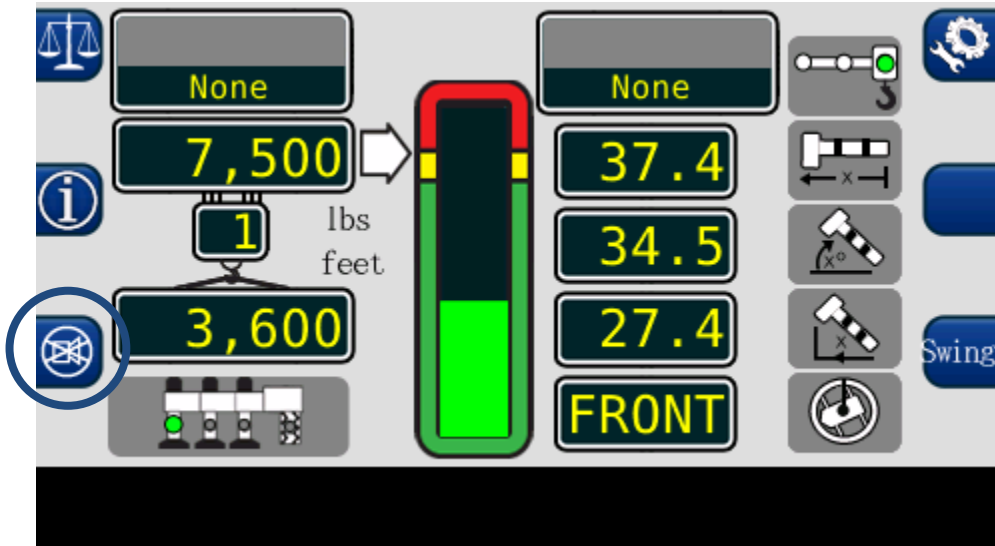

The cancel alarm button is used to silence the audible alarm. Pressing this button once will cancel an audible alarm from an:

- Overload
- ATB Alarm
- Outrigger Discrepancy
- Operator Programmable Alarm.

The audible alarm remains cancelled until the condition which caused the alarm has been resolved, or until a new FKO condition occurs.

RESET FUNCTION KICK-OUT

When rigging the machine, it may be necessary to place the boom in a position which could cause a function kick-out. In this situation, it would be necessary to use the bypass (Cancel Alarm Button). The cancel alarm button is also used to reset the function disconnect relay. Press and hold the button for 5 seconds to reset the relay. A second beep is heard confirming the bypass. Continue to hold the button to maintain the function kick-out.

Should a different alarm condition occur while the relay is overridden, the new alarm will cause another function kick-out. When the condition which caused the alarm is no longer present, the function disconnect relay will reset to the normal condition.

WARNING!!

WHEN THE FUNCTION DISCONNECT RELAY IS RESET BY MEANS OF THE CANCEL ALARM BUTTON, THERE IS NO LONGER PROTECTION AGAINST THE CONDITION THAT CAUSED THE FUNCTION KICK-OUT.

OPERATOR PROGRAMMABLE ALARMS

Setting the Operator Alarms

1. Press the configuration button to access the operator alarms from the main working screen.
2. Then press the operator alarm button. The information screen will show the current status of the operator alarms.

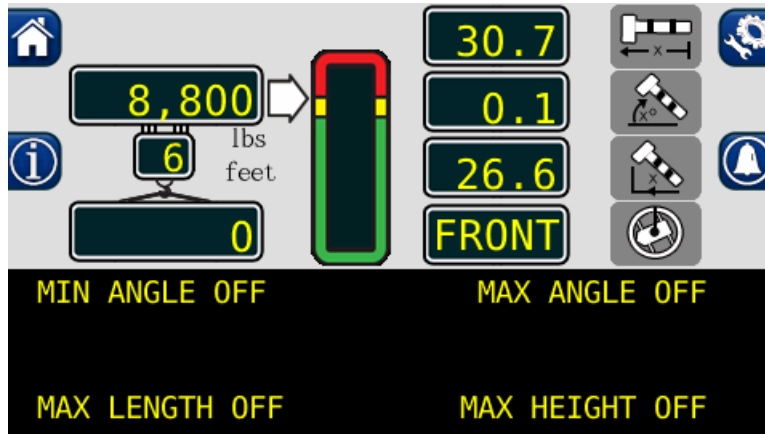

Each button corresponds to the displayed alarm. These buttons operate as a toggle switch. If the alarm to be set is OFF, pressing the button will turn the alarm ON. If the alarm to be set is ON, pressing the button will turn the alarm OFF.

NOTE: Press the operator alarm button in order to cycle through the various user programmable alarms. Press the home button to return to the main screen. Exit at any time.

When operator alarms are set, the orange alarm will appear. An example below:



OPERATOR PROGRAMMABLE ALARMS

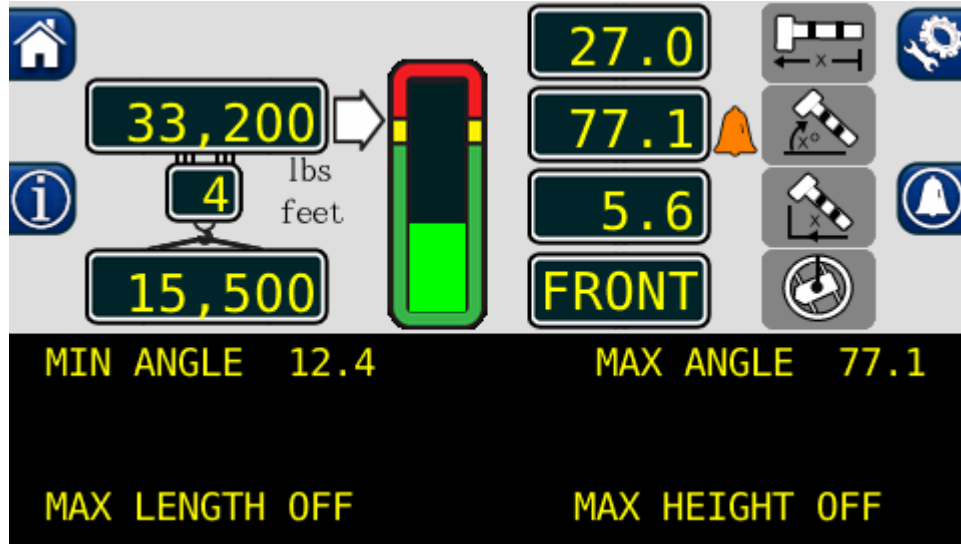

Setting the Minimum Boom Angle Alarm

1. Move the boom to the desired minimum angle, in this example, 12.4°.
2. Press the “MIN ANGLE OFF” button.
3. The display will show the desired minimum angle, in this example, 12.4°.
4. Press the “MIN ANGLE” button again to cancel the alarm. The display will read: “MIN ANGLE OFF”.

Setting the Maximum Boom Angle Alarm

1. Move the boom to the desired maximum angle, in this example, 77.1°.
2. Press the “MAX ANGLE OFF” button.
3. The display will show the desired maximum angle, in this example, 77.1°.
4. Press the “MAX ANGLE” button again to cancel the alarm. The display will read “MAX ANGLE OFF”.

OPERATOR PROGRAMMABLE ALARMS

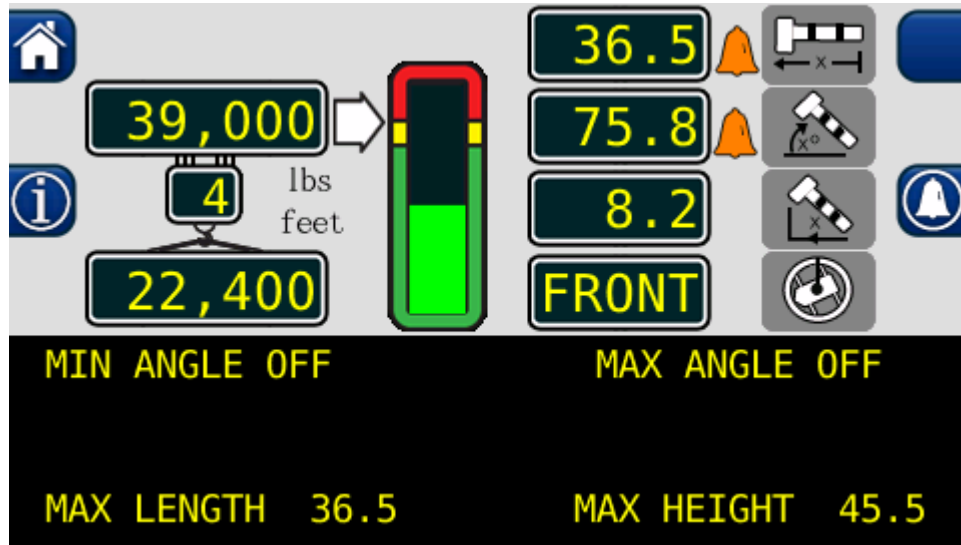

Setting the Maximum Boom Length Alarm

1. Move the boom to the desired maximum length, in this example, 36.5 ft.
2. Press the “MAX LENGTH OFF” button.
3. The display will show the desired maximum length, in this example, 36.5 ft.
4. Press the “MAX LENGTH” button again to cancel the alarm. The display will read “MAX LENGTH OFF”.

Setting the Maximum Tip Height Alarm

1. Move the boom to the desired maximum height, in this example 45.5 ft.
2. Press the “MAX HEIGHT OFF” button.
3. The display will show the desired maximum height, in this example 45.5 ft.
4. Press the “MAX HEIGHT” button again to cancel the alarm. The display will read “MAX HEIGHT OFF”.



POWER to Move the World™

A **DOVER** COMPANY

11135 South James • Jenks, OK 74037

Phone: (918) 298-8300

Fax: (918) 298-8301

www.team-twg.com

Greer Company is a part of TWG.

As a leader in product innovation, Greer Company is committed to the ongoing improvement of its equipment.
We reserve the right to make changes to our products without notice.

©2013 TWG. All rights reserved.