



**HIRSCHMANN**

**PAT**

**LOAD MOMENT INDICATOR**

**MENTOR**

central unit / console



**CALIBRATION / SERVICE MANUAL**

P/N 031-300-190-198 REV A 04/05/06



## NOTICE

Hirschmann makes no warranty of any kind with regard to this material, including, but not limited to, the implied warranties of merchantability and/or its fitness for a particular purpose.

Hirschmann will not be liable for errors contained in this manual or for incidental or consequential damages in connection with the furnishing, performance, or use of this manual. This document contains proprietary information, which is protected by copyright, and all rights are reserved.

No part of this document may be photocopied, reproduced, or translated to another language without the prior written consent of Hirschmann.

Hirschmann reserves proprietary rights to all drawings, photos and the data contained therein. The drawings, photos and data are confidential and cannot be used or reproduced without the written consent of Hirschmann. The drawings and/or photos are subject to technical modification without prior notice.

All information in this document is subject to change without notice.

### MANUAL REVISIONS

REV	DATE	NAME	DESCRIPTION
-	02/03/06	SB	ECN 05-194
A	04/05/06	SB	ECN 06-070



## **PSR Professional Service & Repair Inc.**

Professional Service & Repair Inc. is a full-service mobile crane repair, inspection, and certification company. At Professional Service & Repair we understand the critical aspect of your crane being operational to your project schedule and budget. We will deliver world class service to have your crane operational in the minimum amount of time.

PSR is the global provider for sales, repair and installation of Load Moment Indicating (LMI) systems, Anti-Two Block Systems (A2B), and Rated Capacity Indicating systems. Please contact us with your crane repair and certification needs today.

PSR is the name businesses trust for crane repair, inspection, and certification.

**Main Line: 706-718-0856**

**Fax: 706-569-7004**

**E-Mail: [jeff@psrinc.biz](mailto:jeff@psrinc.biz)**

**P.O. Box 6506  
Columbus, GA  
31917-6506**

## TABLE OF CONTENTS

<b>1</b>	<b>GENERAL INFORMATION .....</b>	<b>1</b>
<b>2</b>	<b>WARNINGS.....</b>	<b>1</b>
<b>3</b>	<b>SYSTEM DESCRIPTION.....</b>	<b>2</b>
1.	<b>DESCRIPTION OF A CAN BUS SYSTEM.....</b>	<b>2</b>
2.	<b>DESCRIPTION OF THE SYSTEM COMPONENTS .....</b>	<b>3</b>
<b>4</b>	<b>CONSOLE INSTALLATION .....</b>	<b>4</b>
<b>5</b>	<b>ANGLE SENSING .....</b>	<b>5</b>
<b>6</b>	<b>LENGTH SENSING .....</b>	<b>8</b>
<b>7</b>	<b>PRESSURE SENSING .....</b>	<b>11</b>
<b>8</b>	<b>LOAD SENSING .....</b>	<b>12</b>
<b>9</b>	<b>CAN-BUS COMMUNICATION .....</b>	<b>13</b>
1.	<b>E61.....</b>	<b>13</b>
2.	<b>E62.....</b>	<b>14</b>
3.	<b>E63.....</b>	<b>14</b>
4.	<b>E64.....</b>	<b>14</b>
5.	<b>E65.....</b>	<b>15</b>
<b>10</b>	<b>A2B PROBLEM .....</b>	<b>16</b>
<b>11</b>	<b>TROUBLESHOOTING A SENSOR PROBLEM USING THE DISPLAY.....</b>	<b>17</b>
<b>12</b>	<b>SPARE PART LISTINGS .....</b>	<b>18</b>
1.	<b>CONSOLE ASSY, (WIRED) W/RAM MOUNT.....</b>	<b>18</b>
2.	<b>PRESSURE TRANSDUCER BLOCK,.....</b>	<b>18</b>
3.	<b>CABLE REEL, LWG508.....</b>	<b>18</b>
<b>13</b>	<b>SERVICE SCREEN FOR SENSOR CALIBRATION .....</b>	<b>18</b>
1.	<b>ACTIVATING THE SERVICE SCREEN FOR SENSOR CALIBRATION.....</b>	<b>18</b>
2.	<b>ZERO-SETTING THE TRANSDUCER INPUTS .....</b>	<b>18</b>
3.	<b>CALIBRATE LENGTH INPUT .....</b>	<b>18</b>
4.	<b>CALIBRATE ANGLE INPUT .....</b>	<b>18</b>
5.	<b>CALIBRATE SLEW ANGLE .....</b>	<b>18</b>
6.	<b>RADIO A2B CONFIGURATION. ....</b>	<b>18</b>
7.	<b>LENGTH SENSOR CALIBRATION.....</b>	<b>18</b>
8.	<b>CABLE REEL LENGTH CABLE REPLACEMENT PROCEDURE .....</b>	<b>18</b>
<b>14</b>	<b>ERROR CODES.....</b>	<b>18</b>
<b>15</b>	<b>TROUBLESHOOTING MOISTURE .....</b>	<b>18</b>
1.	<b>WATER INGRESS.....</b>	<b>18</b>
2.	<b>CONDENSATION.....</b>	<b>18</b>

## 1 GENERAL INFORMATION

This service manual is designed to assist a service or maintenance person in identifying system problem areas or malfunctions. A digital voltmeter with the capability to measure current will be required, along with standard maintenance and service tools. NOTE: Knowledge of how to use a voltmeter to measure both voltage and current is assumed.

### REFERENCE:

For system operation, refer to the consoles operator's manual 031-300-190-197.

## 2 WARNINGS

The LMI is an operational aid that warns a crane operator of approaching overload conditions and of over hoist conditions that could cause damage to equipment and personnel.

The device is not, and shall not, be a substitute for good operator judgment, experience and use of accepted safe crane operating procedures.

The responsibility for the safe crane operation shall remain with the crane operator who shall ensure that all warnings and instructions supplied are fully understood and observed.

Prior to operating the crane, the operator must carefully and thoroughly read and understand the information in this manual to ensure that he knows the operation and limitations of indicator and crane.

Proper functioning depends upon proper daily inspection and observance of the operating instructions set forth in this manual. Refer to Section 6. *Pre-Operation Inspection and Calibration Verification* of this handbook.



**The LMI can only work correctly, if all adjustments have been properly set. For correct adjustment, the operator has to answer thoroughly and correctly all questions asked during the setup procedure in accordance with the real rigging state of the crane. To prevent material damage and serious or even fatal accidents, the correct adjustment of the LMI has to be ensured before starting the crane operation.**

### 3 SYSTEM DESCRIPTION

The Mentor system is a CAN bus system consisting of a central micro processor unit/operating console, length/angle sensor, pressure transducers, and anti-two block switches.

The Load Moment Indicator system operates on the principle of reference/real comparison. The real value, resulting from the pressure measurement is compared with the reference data, stored in the central processor memory and evaluated in the micro processor. When limits are reached, an overload warning signal is generated at the operator's console. At the same time, the aggravating crane movements, such as hoist up, telescope out and boom down, will be stopped.

The fixed data regarding the crane, such as capacity charts, boom weights, centers of gravity and dimensions are stored in memory in the central processor unit. This data is the reference information used to calculate the operating conditions.

The operating modes are selected by the operating mode key on the console by scrolling through the text messages defining the boom truck configuration.

The crane load is measured by pressure transducers attached to the piston and rod side of the hoist cylinders.

Boom length and boom angle are transmitted by length/angle CAN bus node mounted on the side of the boom in the angle sensor box. The length sensor/cable reel is mounted inside the base which measures the boom length.

The crane load is measured by pressure transducer block attached to the piston and rod side of the hoist cylinders.

The interactive user guidance considerably simplifies the input of operating modes as well as the setting of geometry limit values.

#### 1. DESCRIPTION OF A CAN BUS SYSTEM

CAN stands for "Controller Area Network". Its intended use is as a serial bus system for a network of controllers. Each controller connected through a CAN chip is called a "node" and is mostly used to acquire data from a sensor. All nodes are connected to a common bus and all nodes are able to simultaneously read the data on that bus. Also, all nodes are able to transmit data on that bus however only one node at a given time has write access to the bus. If the message is relevant, it will be processed; otherwise it is ignored. The unique identifier also determines the priority of the message. The lower the numerical value of the identifier, the higher the priority.

The cable bus is a twisted pair of shielded wire. Data can be transmitted in blocks from 0-8 bytes at a maximum transfer rate of 1 Mbit/s for networks up to 40 meters. For longer network distances the maximum transfer rate must be reduced to 50 Kbit/s for a 1 km network distance. CAN will operate in extremely harsh environments and the extensive error checking mechanisms ensure that any transmission errors are detected.

## 2. DESCRIPTION OF THE SYSTEM COMPONENTS

**Central Unit/Console:** Inside the console there is a CPU and connection board. The board has a hard mounted connector for power, ground, bus controller, and slew indication. Displays all geometrical information such as actual load, maximum load permitted by load chart, working radius, and length, angle, and head height of main boom. It also has LED's for operating condition "OK", overload, and a pre-warning. An output to an alarm horn and a warning light are also available. The display allows for a simple configuration setup, as well as sensor calibration (zero adjustment), and troubleshooting sensor output screen.

**Pressure Sensor:** The pressure sensor transforms hydraulic pressure into an electric signal. A pressure sensor block houses two sensors, CAN bus controller, and two bus connectors. One pressure sensor is connected to the piston side of the lift cylinder and the other to the rod side.

**The Length-Angle Transducer:** The length-angle sensor (LWG), often referred to as the "cable reel", is a combination of two transducers in one box, installed at the base section of the boom. It measures the length and the angle of the boom.

A reeling drum drives a potentiometer, which is the length transducer. Part of the length transducer circuit is the length cable on the drum, which is a two-conductor cable (screen and live). It is connected to the anti-two-block switch at the boom head and to a slip ring body in the LWG.

The angle transducer is a potentiometer driven by a weighted pendulum that is oil damped. Both length and angle transducer are connected to a CAN bus controller board, which is connected to the bus system.

**Anti-Two-Block Switch:** The anti-two-block switch monitors the load block and it's relationship with the head of the boom. In working condition the switch is closed. When the hook block strikes the weight the circuit opens, disengaging a relay output to the lock out solenoid valves, where applicable. To check the cable for damage, (short circuit to ground) there is a 4.7k resistor between ground and the contact of the switch, to give a signal back to the central unit. The weight at the anti-two-block switch keeps the switch closed until the hook block strikes it.



## 4 CONSOLE INSTALLATION

Install the Mentor console with proper positioning within the field of vision and operating area of the crane operator.

There is a standard length of cable (with multi-pin connector) supplied with the Mentor console. Ensure there is an adequate length of cable between the console and the crane wiring.

The console has a mount that allows the console to be swiveled into any direction and to be mounted in a variety of locations and on nearly any surface. Choose a location that is in line of site of the sensor and within reach of the operator. Securely attach the two RAM mount bases onto a solid surface for the left and right side operation. The console cable may not fit through goose neck/conduit as existing wiring; therefore, run the console cable to the outside of the conduit and insure there no interference.

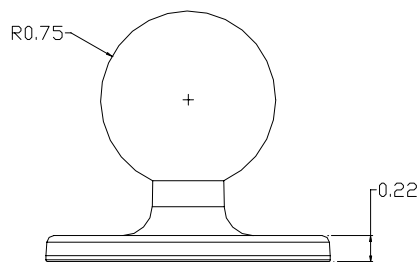
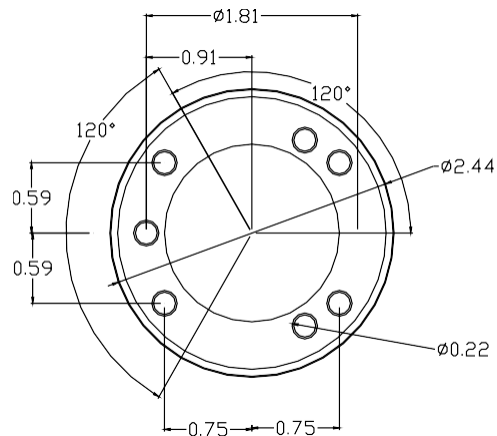
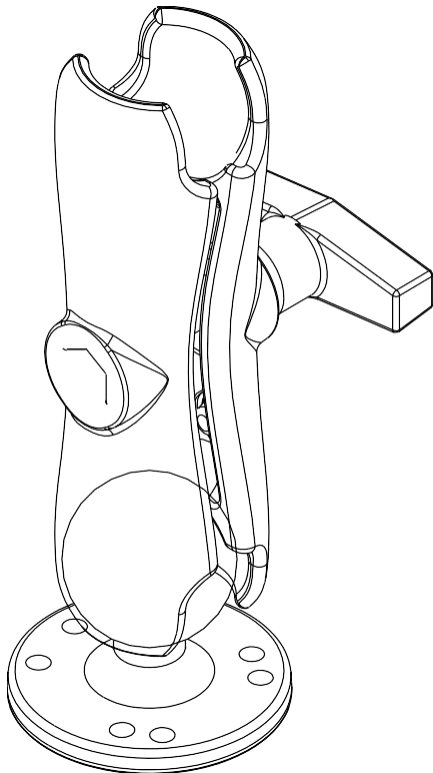

## 5 ANGLE SENSING

The System measures the angle of the main boom of the machine with an angle sensor. The angle sensor is contained within the cable reel, located on the left side of the main boom.

Block Diagram

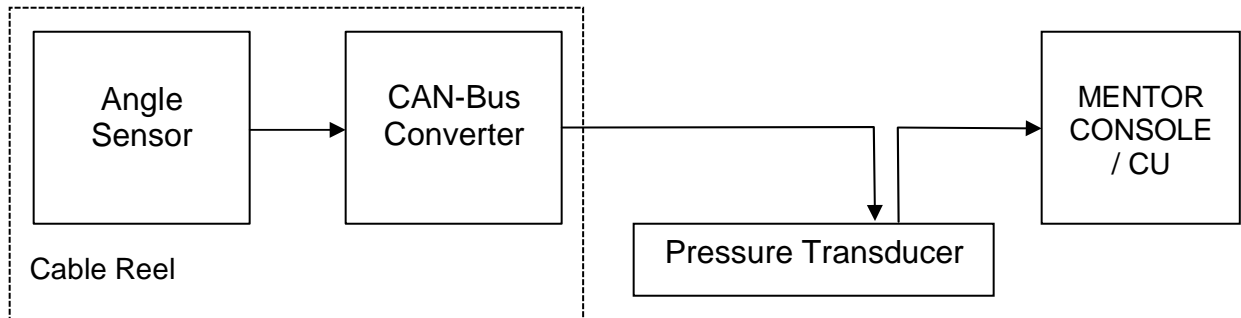

The signal runs from the angle sensor to the Can-Bus converter board, both located in the cable reel. From there, it travels as digital information on the CAN-Bus to the pressure transducer, which acts as a T-connector to the main CAN-Bus running to the central unit.

So, what do you do when you are having a problem with your angle read-out?

Start by verifying the angle display. Refer to the section "[Troubleshooting A Sensor Problem Using The Display](#)" to call up the sensor signal on your console display. The CAN-Bus is digital and as such will either transmit the signal correctly or not at all. If your readings are off, you have to determine what is causing the problem. Start by opening the cable reel and locate the angle sensor (right) and the CAN-Bus converter board (left):

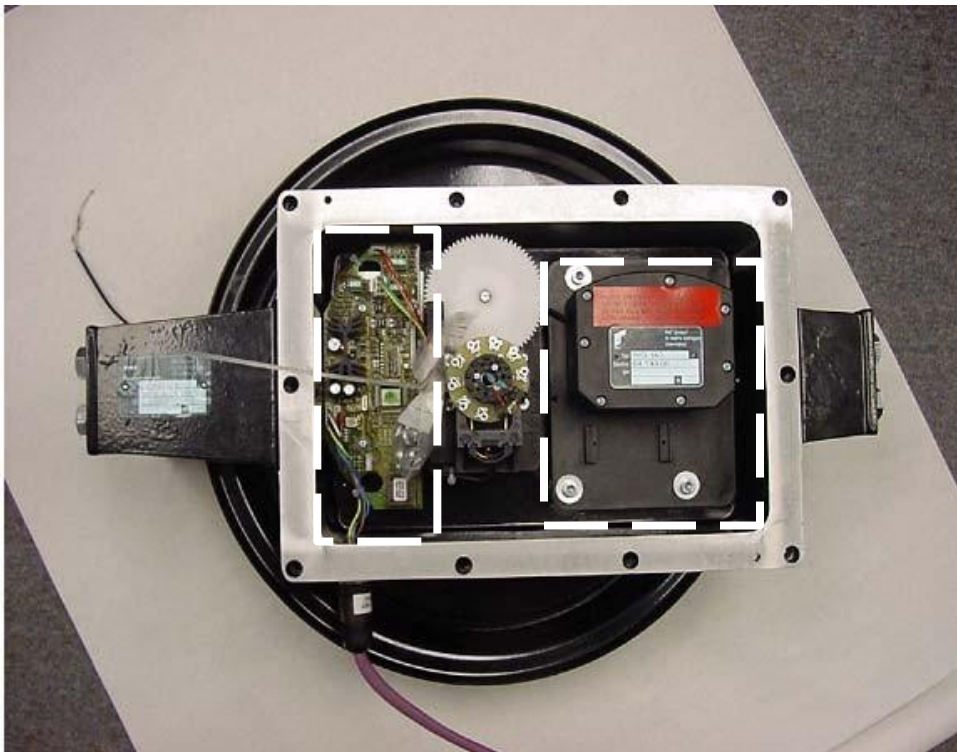

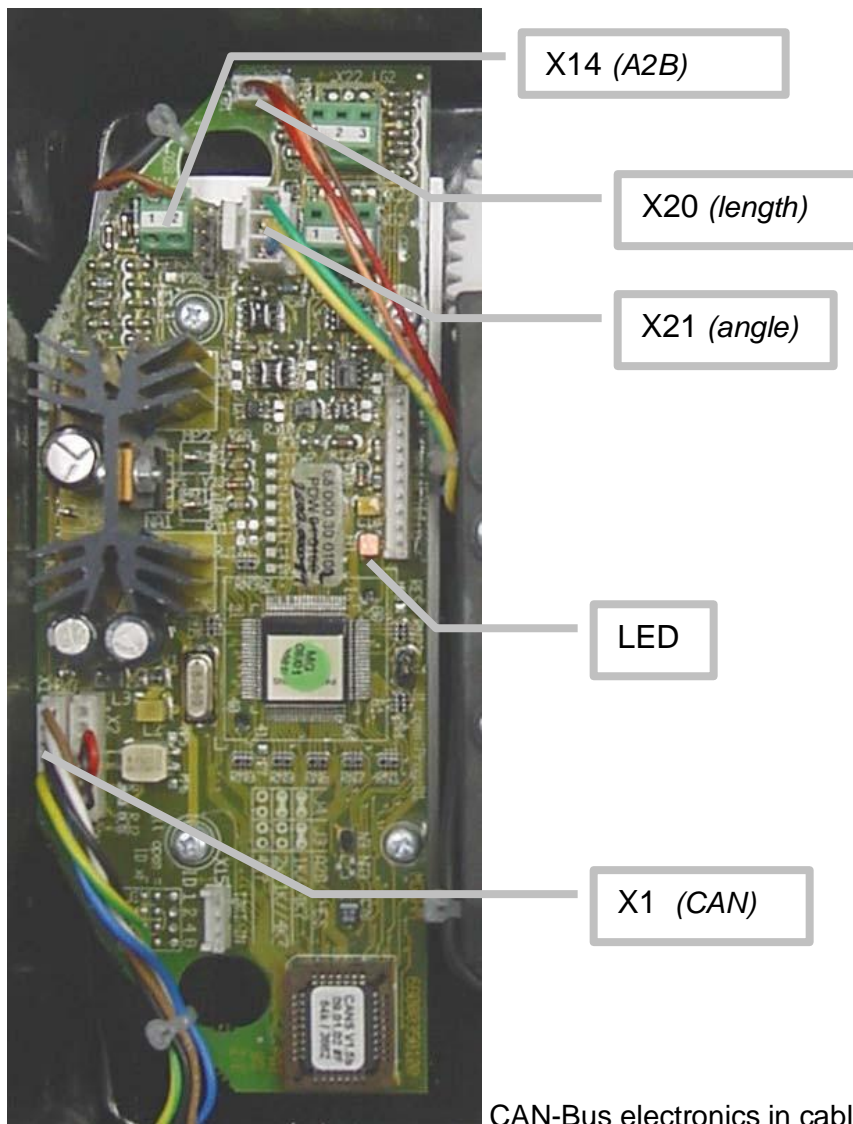

CAN-Bus electronics in cable reel.

The angle sensor has a potentiometer built in that is driven by a pendulum. As the angle changes, so will the pendulum and with it the potentiometer's axle. The converter board supplies a constant voltage of 5V to the angle sensor and in return monitors the voltage of the potentiometer. The terminal used is X21. The angle sensor is connected as follows:

Terminal X21	
1	+ 5V
3	Signal
5	GND

Verify that the sensor is being supplied with 5V by measuring between pin 5 (GND) and Pin 1 (+) of terminal X21. If the voltage is outside of a range of 4.75 to 5.25V, the converter board might be defective. Unplug angle sensor and measure again. If the voltage is still off, exchange converter board. If unplugging the angle sensor made the voltage return into the acceptable range, exchange angle sensor. If the voltage is correct continue:

The angle sensor returns a voltage between 1.875V at 90 degrees and 3.125V at 0 degrees:

<b>Angle Sensor Signal on Pin 3</b>	
Angle	Voltage
90	1.875
75	2.083
60	2.292
45	2.500
30	2.708
15	2.917
0	3.125

*Note: Actual voltages will vary slightly.*

Measure this voltage between Pin 5 (GND) and Pin 3 of Terminal X21.

If you need to determine the angle for voltages other than the above, do so by using the following formula:

$$\text{Angle (degrees)} = 90 \text{ degrees} - ((\text{Voltage} - 1.875) * 72)$$

If this angle matches your actual angle, but the indicated angle varies by more than  $\pm 0.25^\circ$ , the angle sensor is fine and the error is somewhere else. If this angle varies significantly from your actual angle, the angle sensor is bad and needs to be exchanged. Otherwise, continue:

At this point, you have verified that the angle sensor is giving you the right output to match your actual angle, but the system is displaying the wrong angle. If you can rule out software and operator error, it is most likely that the converter board is defective and it needs to be exchanged.

## 6 LENGTH SENSING

The system measures the length of the main boom of the machine with a length sensor. The length sensor is contained within the cable reel, located in the base of the main boom.

Block Diagram

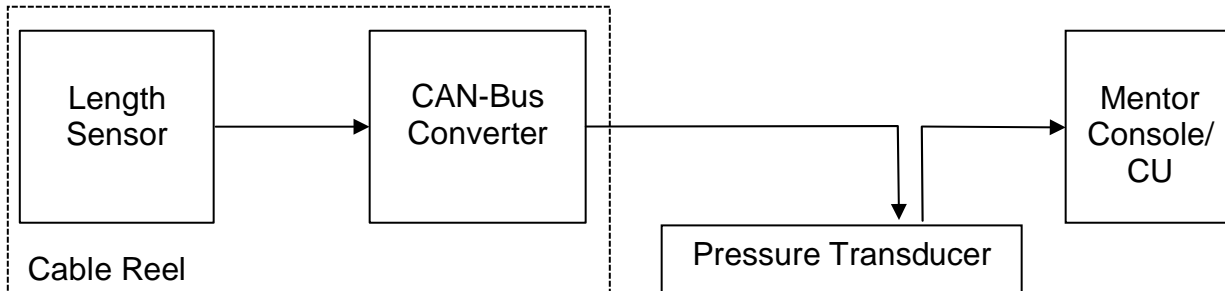

The signal runs from the length sensor to the CAN-Bus converter board, both located in the cable reel. From there, it travels as digital information on the CAN-Bus to the pressure transducer, which acts as a T-connector to the main CAN-Bus running to the console.

So, what do you do when you are having a problem with your length read-out?

Start by verifying the length display. Refer to the section "[Troubleshooting A Sensor Problem Using The Display](#)" to call up the sensor signal on your console display. The CAN-Bus is digital and as such will either transmit the signal correctly or not at all. If your readings are off, you have to determine what is causing the problem. Start by checking the length cable tension, the cable reel has 5-8 turns of pre-loading on the reel. Opening the cable reel and locate the length sensor (right) and the CAN-Bus converter board (left):

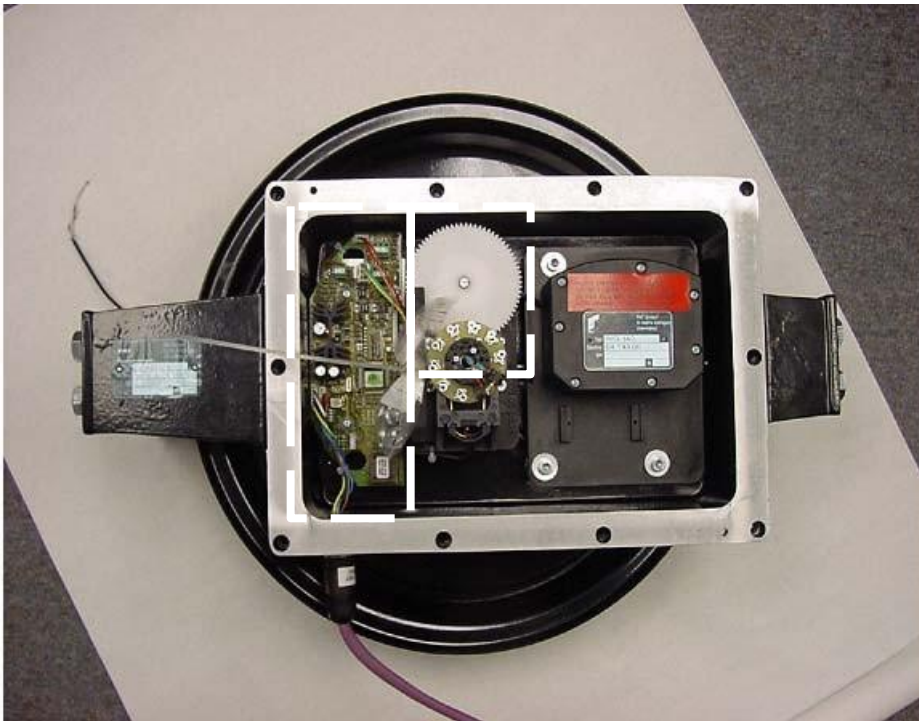

Fully retract the boom and turn the screw of the length potentiometer with a small screwdriver counter clockwise to a soft stop. That should bring the sensor voltage to 0V (+/- 0.1Volt). Measure voltage between Pin 5 (-) and Pin 3 of Terminal X20 and compare.

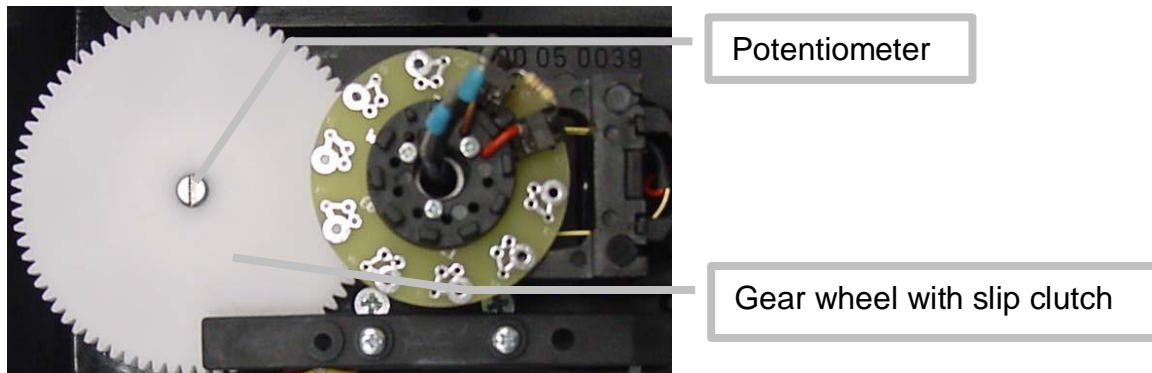

Go back to your indication screen and compare length indicated and actual again. If the indicated length varies significantly from your actual length (more than 0.3 feet), the length sensor might be bad and needs to be exchanged. Note, however, that the error could also be in the software or in the converter board.

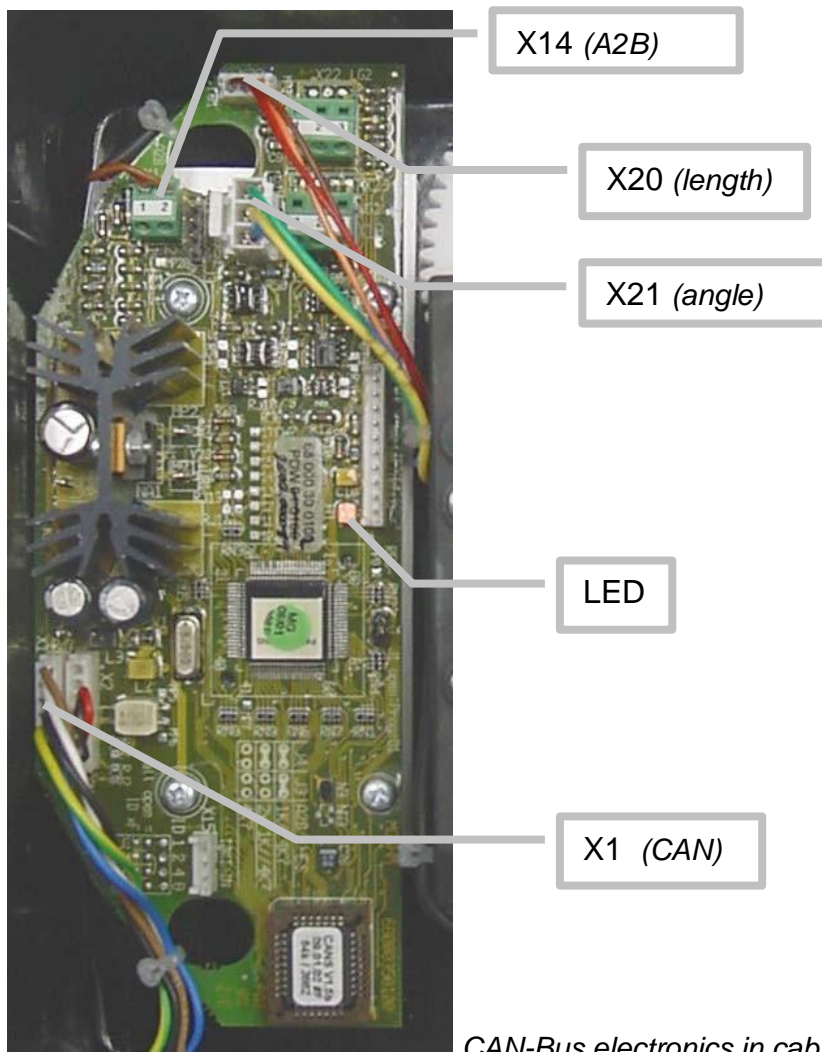

CAN-Bus electronics in cable reel.

The length sensor has a potentiometer built in that is driven by a gear drive from the cable drum. As the length changes, the cable drum will turn and with it the potentiometer's axle. The converter board supplies a voltage of about 4.7V to the length potentiometer and in return monitors the output voltage of the potentiometer. The terminal used is X20. The length sensor is connected as follows:

<b>Terminal X20</b>	
1	+ (~ 4.8V)
3	Signal
5	- (~ 0.2V)

Verify that the sensor is being supplied with about 4.7V by measuring between pin 5 (-) and Pin 1 (+) of terminal X20. If the voltage is outside of a range of 4.5 to 5 V, the converter board might be defective. Unplug length sensor and measure again. If the voltage is still off, exchange converter board. If unplugging the length sensor made the voltage return into the acceptable range, exchange length sensor. If the voltage is correct continue:

The length sensor returns a voltage between 0.16V at 0 turns of the length pot (= fully retracted) and 4.84V at 10 turns. How many turns you get at full extension depends on the gear ratio, the boom length, the length cable used and the spooling pattern, so we cannot provide a standard table for it.

What we can give you for trouble-shooting, however is the following table that shows the expected output voltage (measured between X20-5 and X20-3 Signal) for each complete turn of the length potentiometer. Note that this does not sync to the number of turns of the cable reel, though:

<b>Length Sensor Signal on Pin 3</b>		
Turns	Voltage X20-5 to X20-3	Voltage GND to X20-3
0	0.00	0.16
1	0.46	0.62
2	0.93	1.09
3	1.40	1.56
4	1.87	2.03
5	2.34	2.50
6	2.81	2.97
7	3.28	3.44
8	3.75	3.91
9	4.22	4.38
10	4.68	4.84

*Note: Actual voltages will vary slightly.*

## 7 PRESSURE SENSING

The System measures the pressure of the boom lift cylinder for both rod- and piston-side. Both sensors are contained within one box that also contains the electronics needed for amplification and creation of the CAN-Bus signal.

Block Diagram:

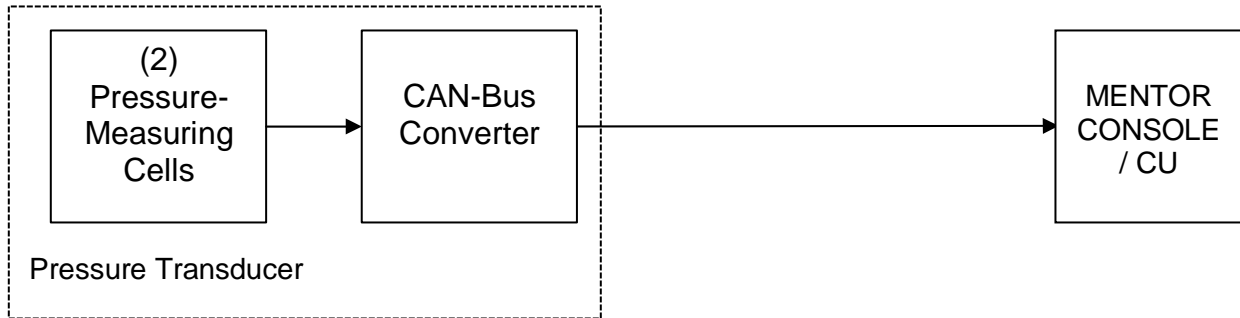

The signal runs from the pressure transducer as digital information on the CAN-Bus to the central unit.

So, what do you do when you are having a problem with your load read-out?

Start by checking the pressure display. Refer to the section "[Troubleshooting A Sensor Problem Using The Display](#)" to call up the sensor signal on your console display.

The easiest spot to check the signal at is when there is no pressure applied to the sensor at all. The only time this is for certain is when your pressure lines are drained and disconnected. In that case, the readout should show about 500mV (+/- 25mV) and 0 PSI. Small variations could be adjusted; see section [Service Screen For Sensor Calibration](#).

The CAN-Bus is digital and as such will either transmit the signal correctly or not at all. If your readings are off, chances are the pressure transducer is defective. Replace.

Note: After exchanging the pressure transducer block, BOTH transducer channels need to be zeroed, see procedure [Zero-Setting The Transducer Inputs](#).



## 8 LOAD SENSING

Please note that the load displayed by the LMI is not a direct measurement, but a calculated value that is based on a lot of factors. Outside of the measured values (sensors), those include:

- Operator settings such as:
  - Operating mode/configuration
  - Parts of Line/Reeving
- Rigging parts such as:
- Hookblock weight
- Sling weights, etc.
- Tip height (length of load line used)
- Boom weights
- Boom attachments such as
- Stowed jibs
- Auxiliary boom nose, etc.

Before checking the system for a load reading problem, make sure all of the above has been ruled out. When you still feel the system is reading a sensor wrong and thus displaying an incorrect load, use the following:

Use the previous sections and the individual sensor signal displayed on the screen to double-check the following:

- boom length reading
- angle transducer reading
- pressure transducer readings

If all are correct, use the zero setting and calibration screens to zero pressure transducers, calibrate angle and length. If you still have a problem, replace pressure transducer block.

## 9 CAN-BUS COMMUNICATION

The System measures the length of the main boom, the angle of the main boom, the pressures of the lift cylinder, and the A2B state of the machine via a CAN-Bus connection. Since this is a digital bus connection, it is not possible to measure the signals on the bus with a multimeter. Instead, the LMI provides you with error codes that give you an indication of the bus state.

The error codes are one of the following:

- E61 Error in the CAN bus data transfer for all CAN units
- E62 Error in the can bus data transfer of the pressure transducer sensor unit
- E63 Error in the can bus pressure transducer sensor unit
- E64 Error in the can bus data transfer of the length/angle sensor unit
- E65 Error in the can bus length/angle sensor unit

Block Diagram

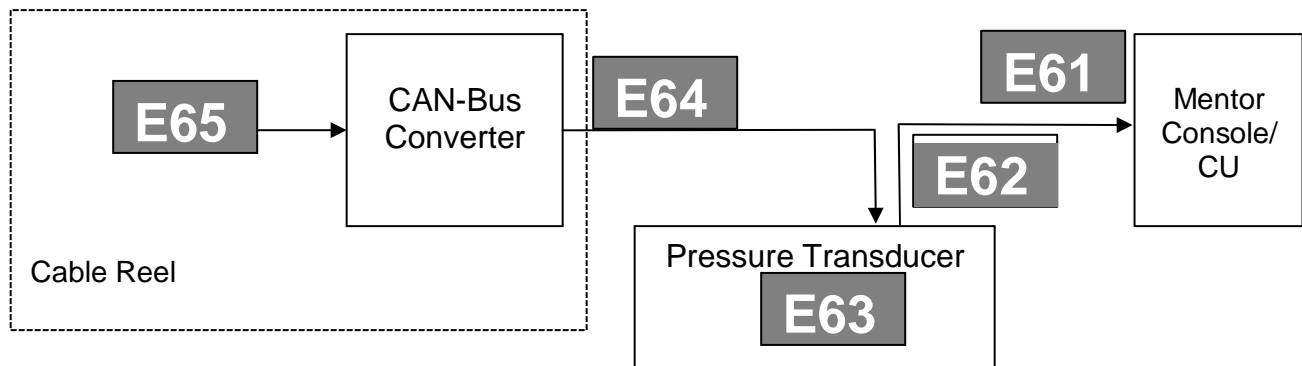

The block diagram tries to clarify that: If the CU does not see any CAN-Bus component, it will report an E61. If it sees only the cable reel, it will report an E62 (pressure transducer missing). If it sees only the pressure transducer, it will report an E64 (cable reel missing). E63 means that the pressure transducer is available, but is reporting an internal error. E65 means that the cable reel unit is available, but is reporting an internal error.

So, what do you do when you are having a problem with one of those codes?

### 1. E61

In case of an E61, start by connecting the two cables on the transducer block together. If an E62 appears, the transducer block must be replaced. If an E61 appears, reconnect the cable from the from the central unit to the transducer block. At this point, if an E61 still appears check your cabling. You can verify that power is being supplied to the sensor by testing the CAN connectors per this layout:

Connector M12, 5 contacts

Pin Layout (CiA DR-303-1 7.2)

- Pin 1 Shield
- Pin 2 + U<sub>b</sub>
- Pin 3 Ground
- Pin 4 CAN High
- Pin 5 CAN Low



Measure between pins 3 and 2 for crane voltage. If you see voltage, check all pins for continuity. The central unit must be replaced if this cable is functioning correctly. If the E61 error code has become an E64, connect the cable reel can bus cable to the transducer block and remove the can bus connector at the cable reel. If this causes an E61 to appear, the can bus cable between the cable reel and transducer block must be replaced. If an E64 remains, use the Ohm-meter to check the connector in the cable reel. Either the connector has failed or the can bus converter boards must be replaced.

## **2. E62**

In case of an E62 the Console is reporting no signal from the pressure transducer. Start by checking your cabling between Console and pressure transducer, even though it is not very likely that there is a problem with it since the same cable carries also the signals from the cable reel and those appear to be fine. You can verify that power is being supplied to the sensor by testing the CAN connectors per the above pin layout. If you are sure that the sensor is being supplied, you have to replace the pressure transducer.

## **3. E63**

In case of an E63, the pressure transducer is reporting an internal problem. You cannot troubleshoot any further, but need to replace the pressure transducer.

## **4. E64**

In case of an E64, the Console is reporting no signal from the cable reel unit. Start by connecting the two cables on the transducer block together. If an E62 occurs, the transducer block must be replaced. If an E61 occurs, measure the cable from the transducer block to the cable reel with an Ohm-meter. Check all pins of the CAN bus cable for continuity and cross-check for short circuits. If the continuity check fails, the cable must be replaced. If the cable appears to be fine, next check the connector at the cable reel. You can verify that power is being supplied to the sensor by testing the CAN connectors per the pin layout (see E61). Replace the connector if this check fails. If the connector checks properly, the board in the cable reel might be defective.

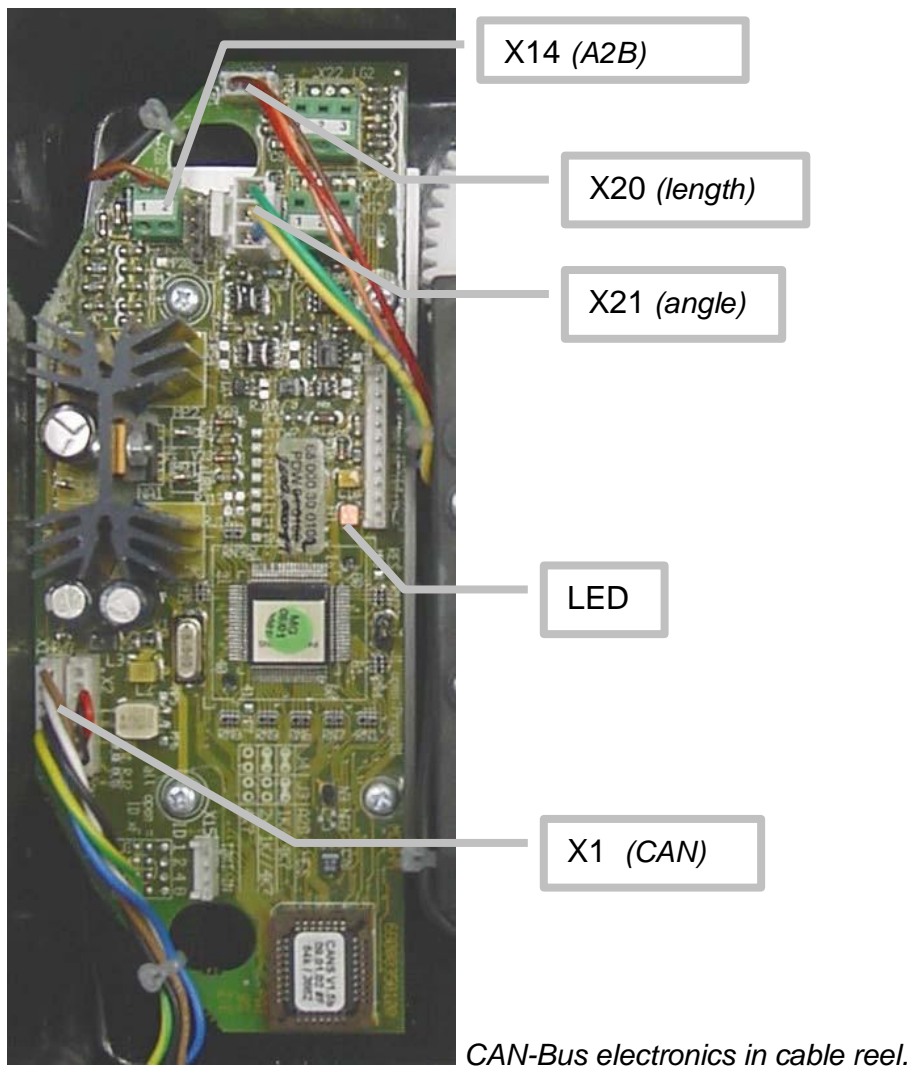

X1 Pin	CAN
1	CAN_SHLD
2	CAN +UB
3	CAN GND
4	CAN_H
5	CAN_L

### 5. E65

In case of an E65, the cable reel is reporting an internal problem. In most cases, this will be an angle sensor, length potentiometer or A2B wiring. Go to those chapters ([Angle Sensing](#), [Length Sensing](#), [A2B PROBLEM](#)) to continue trouble shooting.

## 10 A2B PROBLEM

First, perform the following operations:

Are the control levers locked out and is the crane in an anti-two block condition?

YES, Lower the hook block and/or headache ball to correct two-block condition. If two (2) hoists are in use, both hooks must be lowered.

Is the anti-two block warning light on? Check Bypass plug installed, if not plug appropriate bypass plug into socket of junction box.

Is the Bypass plug installed and the anti-two block warning light on?

Turn power off, remove the bypass plug, and measure the resistance at the boom nose box between terminals 1 and 3 with an ohmmeter. This checks the function of the Anti-Two Block switch. Switch closed = 0Ohms (weight installed); Switch open => 1 Megaohm (weight removed) Ohmmeter reading are correct?

YES, Plug the bypass plug into the boom nose box and refer to system wiring to check wire connections in boom nose box. If wiring is correct, replace Anti-Two-Block switch.

Ensure the bypass plug is plugged into the boom nose box. Measure the A2B signal in the cable reel between X1:Brown and X2:Red wires on the slip ring with an ohmmeter. Switch closed =4700 ±500Ohms; Switch open => 1 Megaohm. Ohmmeter readings are correct?

NO, Check for damaged length cable and wiring. If broken length cable, refer to system wiring.

Measure the A2B signal in the cable reel between terminal 7 and 8 with an ohmmeter. Switch closed =4700 ±500Ohms; Switch open => 1 Megaohm. Ohmmeter readings are correct?

NO, Replace slip ring

Problem with wiring harness, cable reel length/angle board, and/or central unit.

## 11 TROUBLESHOOTING A SENSOR PROBLEM USING THE DISPLAY

To determine whether there is a problem with a sensor, the Mentor system has “sensor output screen” built in to make trouble-shooting easier. This is the right place to start if you are suspecting a problem with a sensor (and you don’t have an error code displayed).

To access the sensor output screen, press  “INFO” button and scroll down to select the analog input screen.

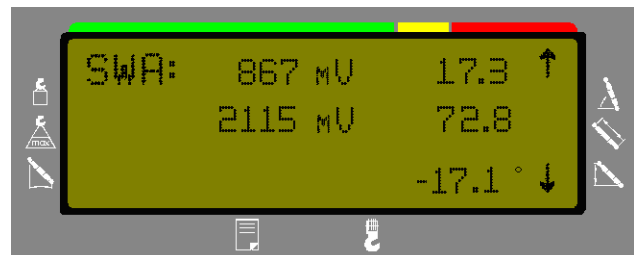
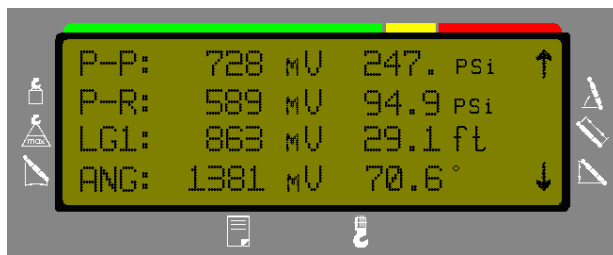

The screen will show all sensor inputs as in the example below. For each sensor, an equivalent voltage is shown in millivolts, along with the physical sensor value that that voltage refers to. Pressure sensors are shown with physical values of [bar], angle sensors and slew sensors in degrees and length sensors in feet (or meter for metric charts).

The values shown in the above screens are just examples of actual values. Refer to the table listed below for actual value ranges.

If you suspect a sensor error or problem with a sensor, compare the indicated physical value of the sensor on the display screen with the real value, i.e. length, angle, etc.

The voltages given are internal calculation values only; you will not be able to actually measure them anywhere on the electronics! Typical values to be expected are:

- Pressure transducers (piston and rod), 500mV @ 0 PSI; 4500mV @ maximum PSI
- Length sensor, 500mV @ retracted boom length; voltage extended depends on the various boom lengths.
- Angle sensor, 4500mV at 0°; 2500mV at 45°; or 500mV at 90°

Please refer to table below for more values.

Voltage Values displayed [mV] +/- 10mV	Value displayed	Value
<b>Pressure Transducers 300 bar, type 314</b>	<i>PSI</i>	<i>Bar</i>
500	0	0
1500	1088	75
2500	2176	150
3500	3263	225
4500	4351	300

Angle Sensor	<i>degrees</i>	
500	90	boom vertical
1500	67.5	
2500	45	
3500	22.5	
4500	0	boom horizontal

Length Sensor	<i>feet</i>	
500	0	fully retracted
1500		
2500		
3500		
4500		

If the displayed value does differ from the actual value, please refer to the following sections to find the cause of the problem:

If the displayed angle is incorrect, please go to section [Angle Sensing](#).

If the displayed length is incorrect, please go to section [Length Sensing](#)

If the displayed pressures are incorrect, please go to section [Pressure Sensing](#)

**SLEW POT SIGNALS:**

Reference Angle	Sig 1 (mA) ±0.03mA	Sig 2 (mA) ±0.03mA
0°	4.00	12.00
45°	8.00	16.00
90°	12.00	20.00
135°	16.00	16.00
180°	20.00	12.00
-135°	16.00	8.00
-90°	12.00	4.00
-45°	8.00	8.00

If the displayed angle is incorrect, please go to section [Slewing Sensing](#). Scroll through the screen to see piston / rod side voltages and pressures, and length and angle voltages and measurements. The values shown in the screen here are just examples of actual values.

To view the digital input/output screen, press  "INFO" button and scroll down to select the digital input / output screen.

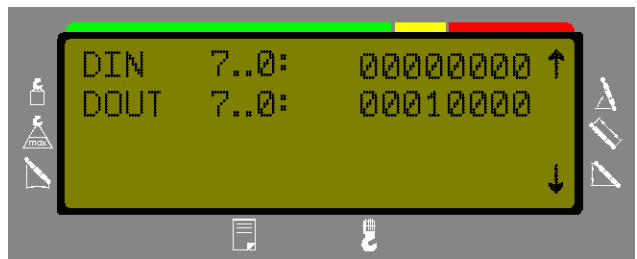

The values shown in the above screen are just examples of actual values.

To access the software version screen, press  "INFO" button and scroll down to software version to view the currently installed software.

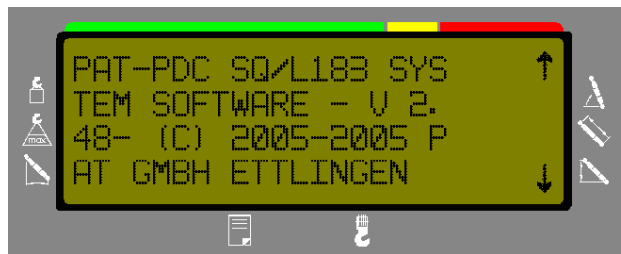



## 12 SPARE PART LISTINGS

### 1. CONSOLE ASSY, (WIRED) W/ RAM MOUNT PART NO. 031-300-060-648



NO.	PART NO.	QTY	DESCRIPTION
1	024-183-100-301	1	FRONTFACE, NATIONAL
2	050-000-100-294	1	LCD, UNIT
3	024-183-100-008	1	HOUSING, PRE-ASSEMBLED
4	024-183-300-001	1	MAIN BOARD, 10...30V
5	024-000-100-103	1	BREATHER ELEMENT
6	031-300-060-382	1	MOUNTING ARM
7	092-000-060-391	1	CONNECTOR, CAN M12 5 PIN
8	024-183-260-010	1	CONNECTOR, M23 19 POL.
9	024-183-290-001	1	CONNECTOR, SUB-D 9 PIN

**2. PRESSURE TRANSDUCER BLOCK,  
DAV314/0014 PART NO. 044-314-060-014**



Piston Side

Rod Side

Cutting ring for pressure transducers  
**PART NO. 000-209-140-016**

Hydraulic bulkhead adapter 9/16-18 JIC 37° x 16m x 1.5  
**PART NO. 000-214-600-093**



CAN bus from pressure transducer to cable reel.  
**PART NO. 031-300-060-454**

### 3. CABLE REEL, LWG508

**PART NO. 068-508-060-001**

NO.	PART NO.	QTY	DESCRIPTION
1	031-300-060-468	1	CABLE REEL ACCY, LWG508 DRUM BODY W/LENGTH CABLE
2	000-673-020-002	139'	LENGTH SENSOR CABLE
3	068-000-300-103	1	BOARD, LENGTH AND ANGLE OUTPUT
4	067-000-300-012	1	LENGTH POTENTIOMETER LWG508
5	064-143-060-009	1	ANGLE SENSOR, WG143/09
6	068-000-110-107	1	SLIP RING ASSEMBLY 2 CONDUCTOR
7*	006-800-005-001	1	25T GEAR WHEEL
8	068-000-110-038	1	75T GEAR WHEEL
9*	092-000-060-387	1	CONNECTOR, 5 POLE W/WIRES
10*	068-000-100-196	1	LID, BLACK
11*	068-000-110-003	1	CABLE REEL ACCY, GASKET FOR COVER
12*	068-000-110-031	10	CABLE REEL ACCY, SCREW/CAPTIVE

\* ITEM NOT SHOWN

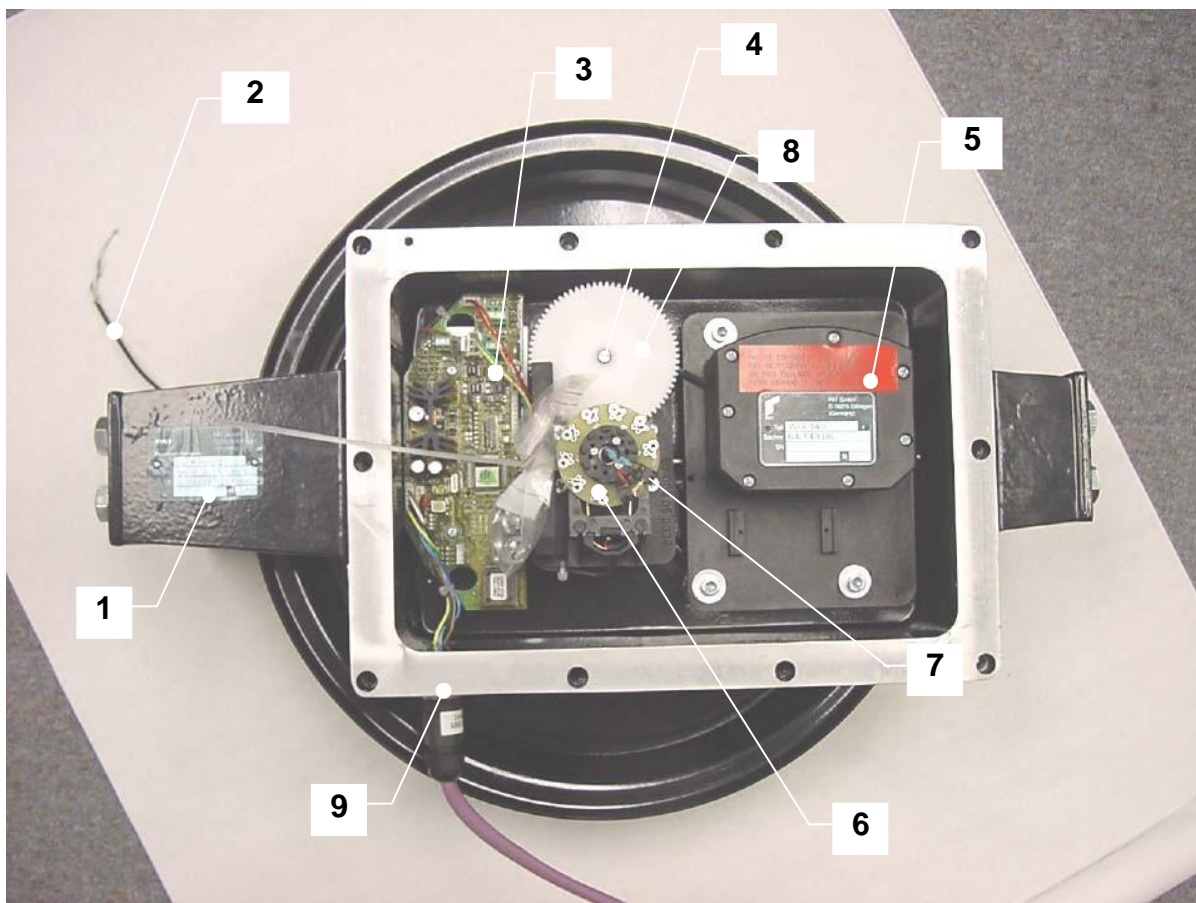

Also see detail on next page.

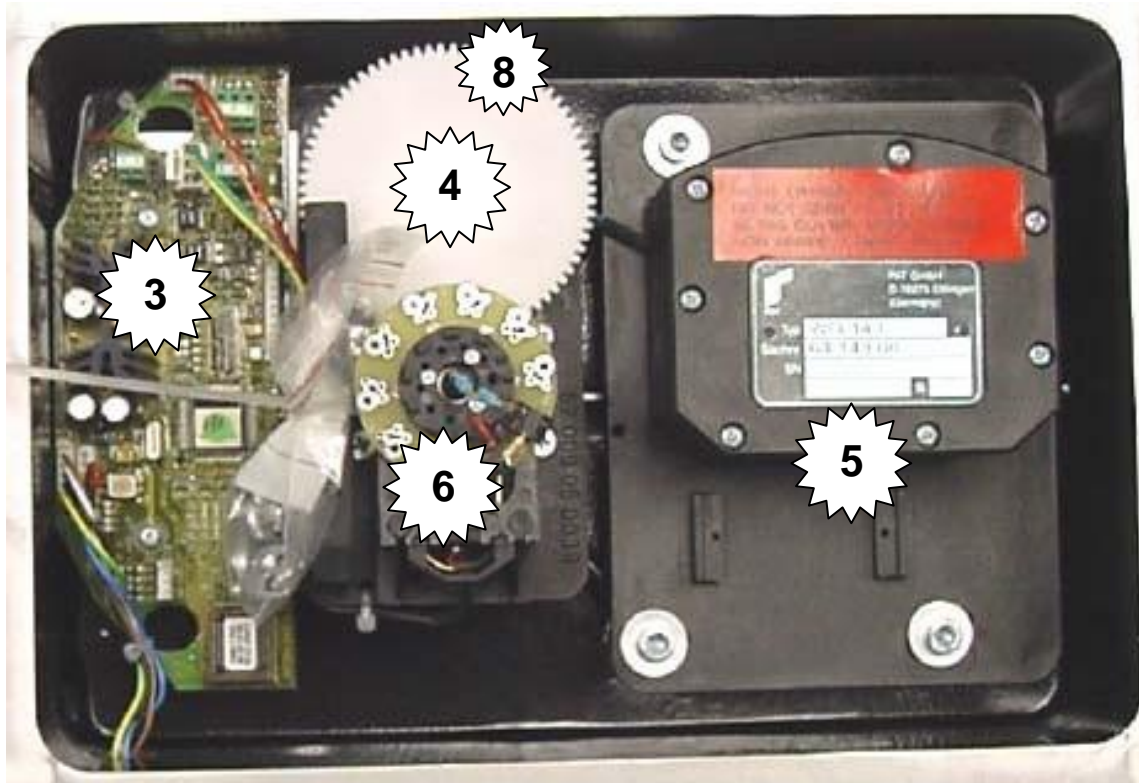

Hirschmann reserves proprietary rights to this drawing and to the data shown there on. The drawing and data are confidential and are not to be used or reproduced without the written consent of Hirschmann. This drawing is subject to technical modification without prior notice.

## 13 SERVICE SCREEN FOR SENSOR CALIBRATION

### 1. ACTIVATING THE SERVICE SCREEN FOR SENSOR CALIBRATION

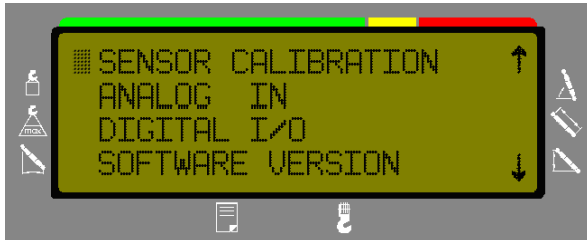

Enter the calibrate sensors menu by using the following procedure:

To start function press  "INFO."



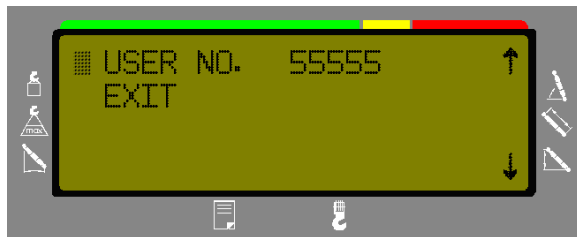

Press  to calibrate sensors.

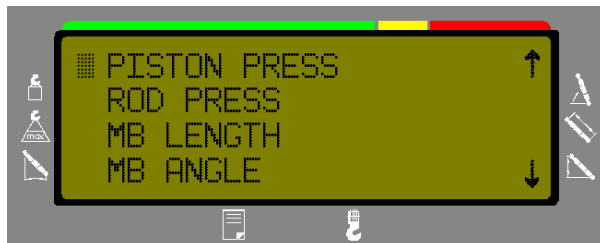

At this point, the five digit Authorization Number (**57595**) must be entered. Use  and  keys to increase and decrease each digit. Use  to confirm entry.





Having successfully entered a valid password, use  and  keys to mark the piston-side, the rod-side zero setting, and length, and angle calibration. The calibration sensor screen will remain available and accessible without entering the user number until system is power off.

## 2. ZERO-SETTING THE TRANSDUCER INPUTS

**NOTE:** The only adjustment for the pressure transducers is the zero point, which is the voltage the transducer outputs when there is no (zero) pressure sensed.

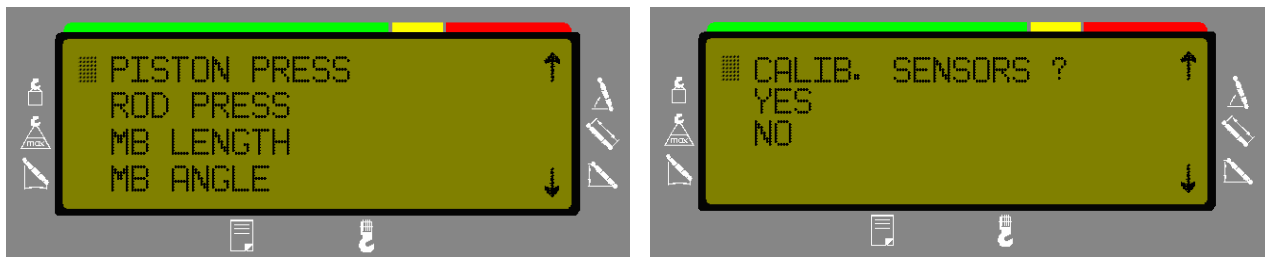

**CAUTION:** Ensure there is no pressure in the hydraulic line when disconnecting the hoses from pressure transducers.

Use  and  keys to mark the piston-side **or** rod-side zero setting. Confirm that you want to calibrate the sensor by selecting 'YES' and pressing  to calibrate selected sensor.



The piston-side or rod-side zero-point setting function is activated as shown in the screens above and pressing





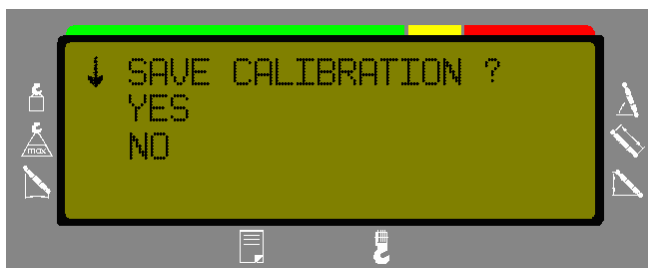

When the boom is in the rest position bleed to continue, press  to continue, and then  to calibrate.

Check the sensor outputs screen to check the zero point. At the zero point, the millivolt should be 0500  $\pm$ 20mV.





Select **EXIT** to leave calibration or select the 'CALIBRATE SENSORS' to calibrate another sensor.

### 3. CALIBRATE LENGTH INPUT

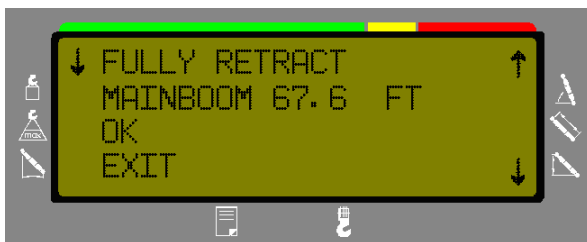
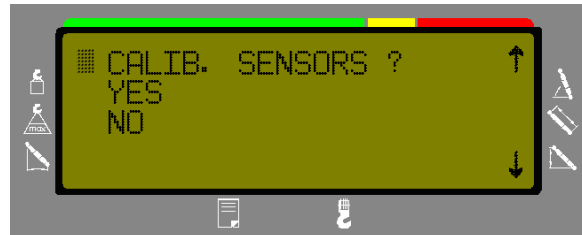
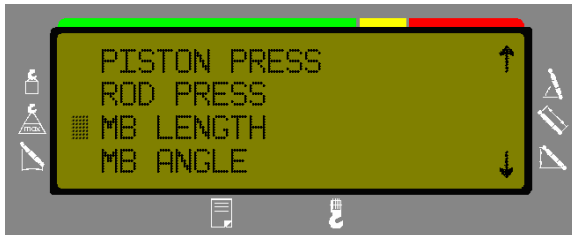
Use  and  keys to select main boom length calibration, and press . Confirm that you want to calibrate the main boom by selecting 'YES' and pressing  to calibrate selected sensor.



Fully retract the main boom, to continue, press . Acknowledge main boom fully retracted, to continue, press . Press  to calibrate.



Fully extend the main boom, to continue, press . Acknowledge main boom fully extended, to continue, press . Press  to calibrate.

Check the sensor outputs screen retracted and extended lengths. Retracted length should be correct at 0500mV and extended boom length will depend on the model.

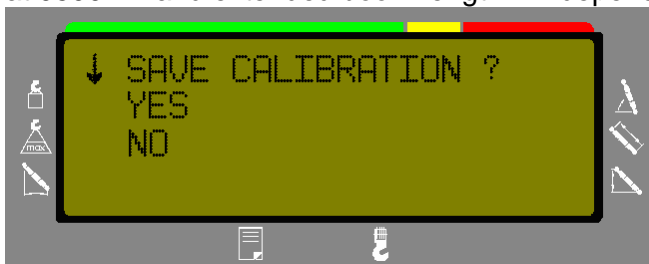





Select **EXIT** to leave calibration or select the 'CALIBRATE SENSORS' to calibrate another sensor.

#### 4. CALIBRATE ANGLE INPUT

The angle sensor is calibrated at different reference angles of approximately 0°, 65°, and 75°. When CHANGE is displayed by the actual boom angle, the boom angle may be calibrated. The previously calibrated angles define the reference angles.

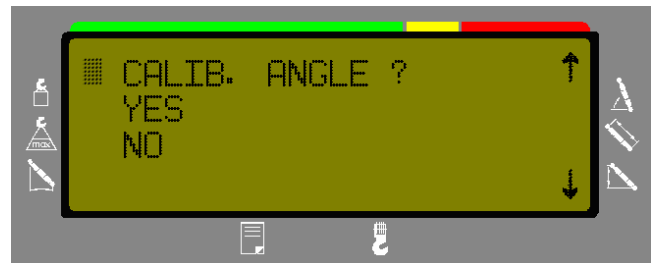
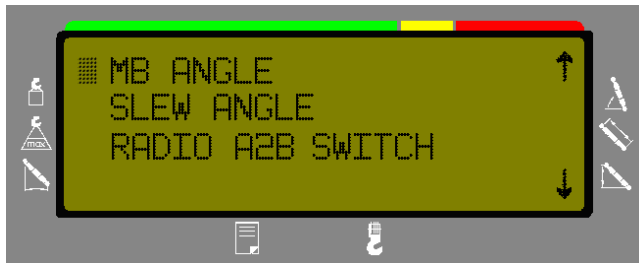

NOTE: This process should be repeated if sensor is ever removed or replaced.

Use  and  keys to select main boom angle calibration, and press . Confirm that you want to calibrate the angle by selecting 'YES' and pressing  to calibrate selected sensor.



Boom down to a flat angle and mechanically adjust the angle sensor. The angle should be set to be +/-0.0 of the measured angle. Material – calibrated inclinometer.







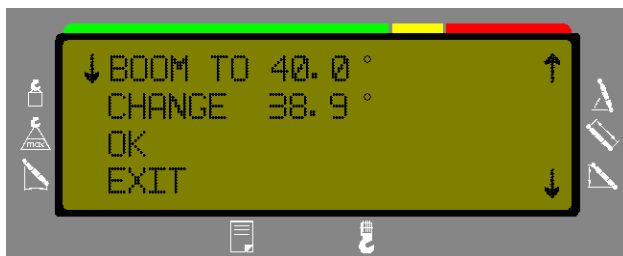

Press  when the sensor is mechanically set.  
Pressing  confirm the mechanical adjustment.

Boom up to the next correction angle, 40° (range 35°- 45°). Note: When the boom angle is within the calibration range, the screen will add the 'CHANGE' and 'OK' text to the screen similar to the screen below. Measure the boom angle with the inclinometer and when the boom is positioned in the calibration range, compare the measured angle to the displayed angle.





Use the  and  keys to select 'CHANGE' then press . The displayed angle should now be flashing. Use the  and  keys to adjust the indicated angle to match the measured angle. After the display shows the correct angle, press .

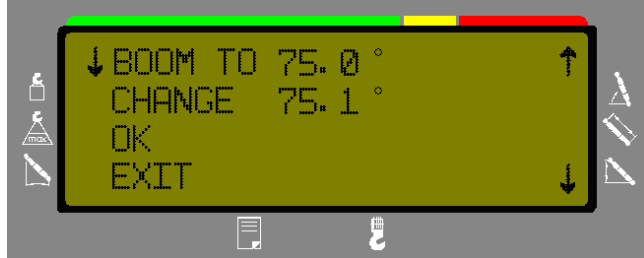
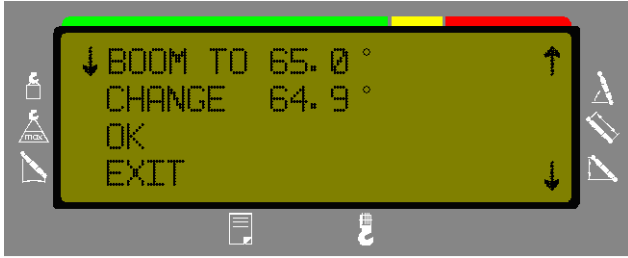

Complete the above procedure to set the correction factor at 65° and 75° boom angle. After 'OK' is selected the system defines a high boom correction angle, 65°. After 'OK' is selected the system defines a high boom correction angle, 75°. After 'OK' the system request the angle sensor calibration is saved.

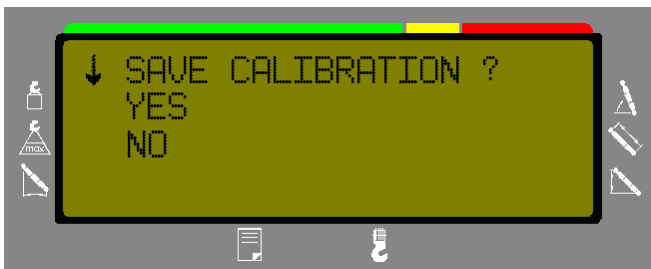





Select **EXIT** to leave calibration or select the '**CALIBRATE SENSORS**' to calibrate another sensor.





Using a calibrated inclinometer placed flat on the main boom, verify that the indicated boom angle matches the measured boom angle within +/- 0.2 degrees. Check the sensor outputs screen for 0°, 40°, 65°, and 75°

main boom angle	millivolts
0°	
40°	
65°	
75°	

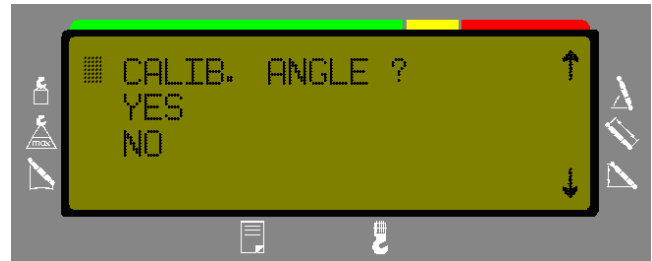
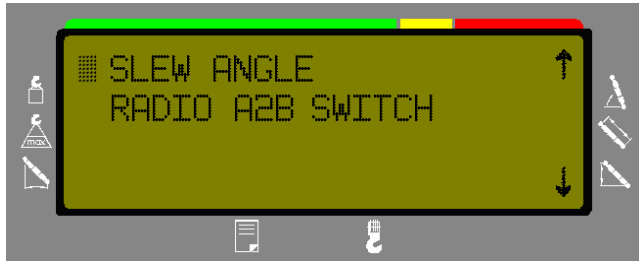
### 5. CALIBRATE SLEW ANGLE

Use  and  keys to slew angle calibration, and press . Confirm that you want to calibrate the slew angle by selecting 'YES' and pressing  to calibrate the selected sensor.  
 Note: Slew Limits are an option that will not be available with all cranes.



Boom to the radius of 0° (+/- 5°) and confirm the calibration by pressing . Use the  and  keys to adjust the radius to 0°, then press . After the display shows the correct radius, press .

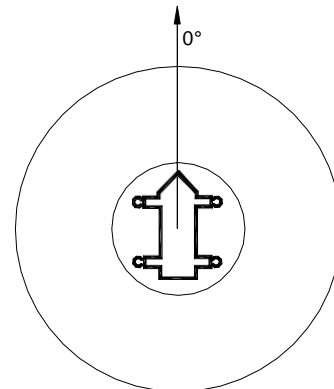
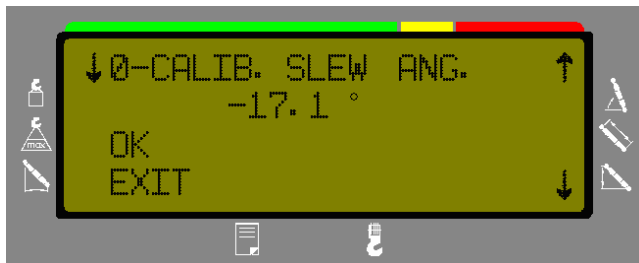

If the radius of the boom is not within the (+/- 5°) tolerance and 'OK' is selected to confirm the calibration, a screen will be displayed indicating the calibration could not be confirmed and further mechanical adjustment is required.

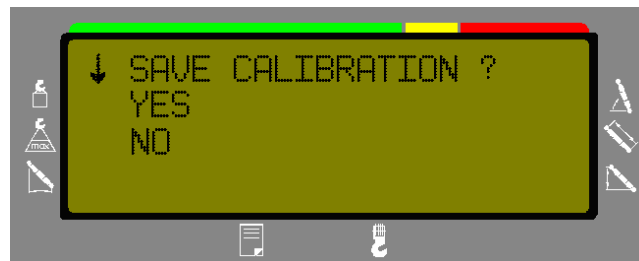

Select 'EXIT' to leave calibration or select the 'CALIBRATE SENSORS' to calibrate another sensor.

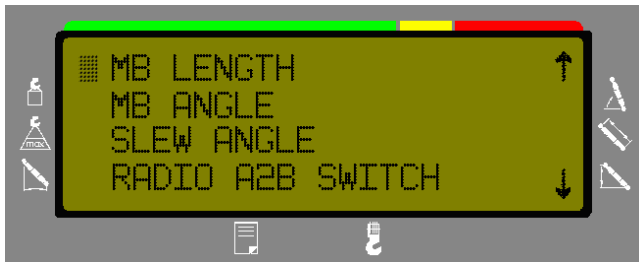

## 6. RADIO A2B CONFIGURATION

Ensure the transmitter is properly located, batteries installed, and the weight and chain has been added to the switch.



Use the  and  arrow buttons to scroll to the radio A2B switch configuration, and press . The EAD error code will flash in the lower corner of the display indicating no valid A2B switch status.

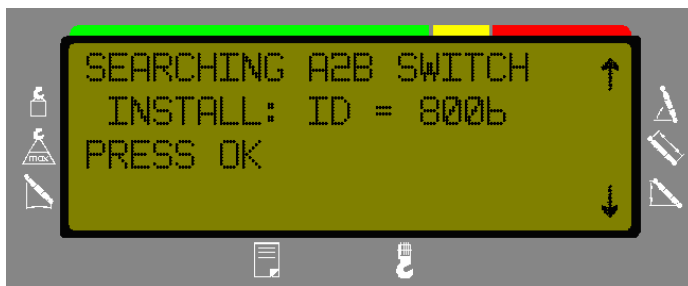

After activation of the switch, the receiver will begin searching for the ID of the A2B transmitter. When the ID has been established, several of the limit lights will flash indicating the A2B switch has been located and the ID number of that switch will be displayed.

Press  to accept the installation of the radio A2B.

## 7. LENGTH SENSOR CALIBRATION

**NOTE:** The length sensor can be calibrated for its zero point and its full range. This means, for the correct voltage for retracted boom and for the extended boom. With retracted boom, the potentiometer of the length sensor has to be at its 0 position, which is all the way counter-clockwise. For extended boom, the adjustment is done by software as described in 6 section [Length Sensor Adjustment Procedure](#).

The length should be calibrated to be about 0.1 feet (or 0.05m for metric) accurate for retracted and extended lengths. Perform the following steps:

Fully retract the main boom and check if indicated length is within 0.1' of actual retracted boom length. If it is not, adjust length potentiometer as described in 6.3.1. Afterwards always adjust retracted length by software as described in section [Length Sensor Adjustment Procedure](#).

### Cable Reel LWG508 Adjustment Procedure

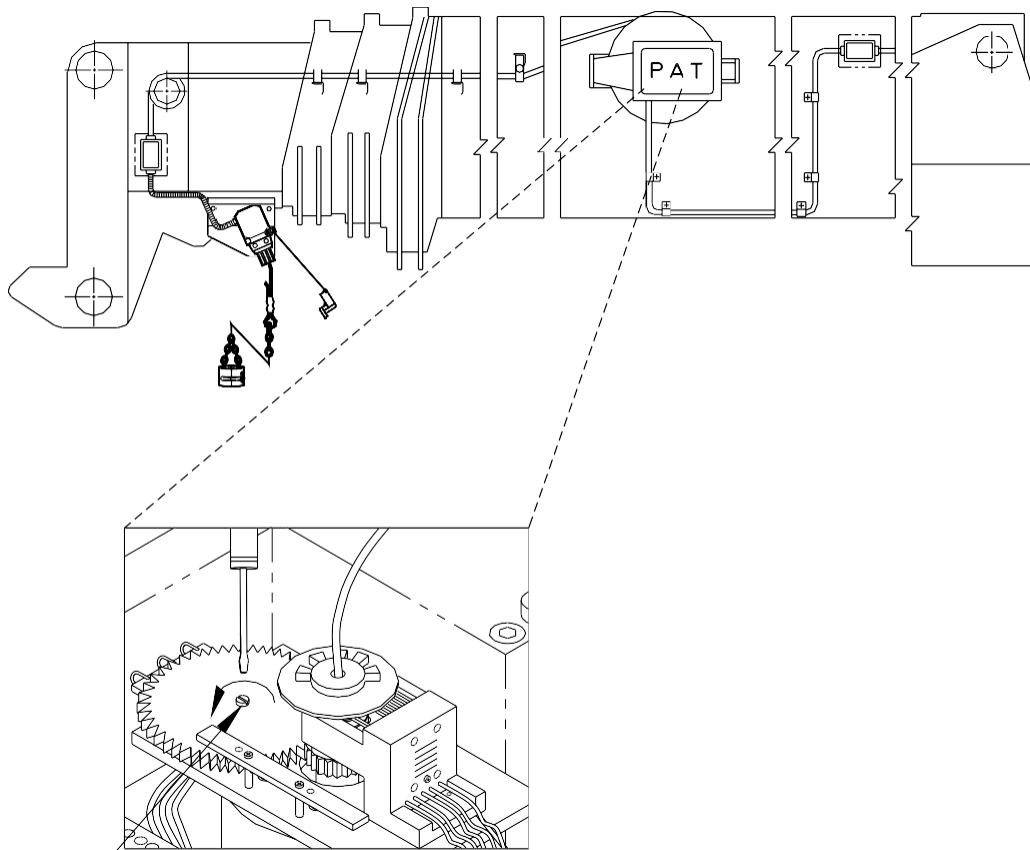

ADJUST LENGTH POTENTIOMETER, WITH BOOM FULLY RETRACTED.  
TURN THE CENTER SCREW COUNTER CLOCKWISE TO A SOFT STOP.

Now perform Length Sensor Adjustment Procedure as detailed in section [Length Sensor Adjustment Procedure](#).

## 8. CABLE REEL LENGTH CABLE REPLACEMENT PROCEDURE

Replace length cable using the following procedure:

Refer to system electrical wiring diagram and cable reel - parts list

1. Cut old cable at cable drum.
2. Disconnect damaged length cable from junction box at the boom nose.
3. Open cable reel cover and disconnect bus connector.
4. Remove cable reel from mounting brackets.
5. Remove damaged length cable, which is mounted to the slip rings in the cable reel, from slip ring terminal.
6. On the backside of the cable reel, open the strain relief attached to the axle in the center of the drum. Pull existing length cable out of the cable reel.
7. Pull new length cable through the hole, pipe and strain relief and push it through the axle of the reeling drum. Tighten new strain relief to ensure sealing.
8. Reconnect the length cable to the slip ring.
9. Remount cable reel to the boom.
10. Turn reeling drum clockwise to spool the new cable neatly onto the drum.
11. Set pre-load on cable reel by turning the drum counter-clockwise 5 to 8 turns.
12. Run the new length cable through the cable guides and wrap the length cable around the boom tip anchor pin (4 or 5 wraps) and secure with tie wraps. Leave enough length cable to connect into the boom tip junction box.
13. Connect the length cable into the boom tip junction box.
14. Reset length potentiometer in length angle transducer (screw is located in center of white gear); with boom fully retracted, turn potentiometer carefully counter-clockwise until it stops. Recheck length and angle display. Refer to section [Cable Reel LWG508 Adjustment Procedure](#).
15. Connect bus connector
16. Follow [Length Sensor Adjustment Procedure](#).

## 14 ERROR CODES

The following Error Code Table gives a brief description of Error Codes elimination. Refer to the noted sections for detailed Troubleshooting information.

Error Code	Error	Possible Cause	Elimination
<b>E01</b>	Fallen below radius range or angle range exceeded	<ul style="list-style-type: none"> <li>Fallen below the minimum radius or gone past the maximum angle specified in the respective load chart due to luffing up the boom too far</li> </ul>	<ul style="list-style-type: none"> <li>Luff down the boom to a radius or angle specified in the load chart.</li> </ul>
<b>E02</b>	Radius range exceeded or fallen below angle range	<ul style="list-style-type: none"> <li>Gone past the maximum radius or fallen below the minimum angle specified in the respective load chart due to luffing down the boom too far</li> </ul>	<ul style="list-style-type: none"> <li>Luff up the boom to a radius or angle specified in the load chart.</li> </ul>
<b>E03</b>	Non-permitted slewing zone (no load area)	<ul style="list-style-type: none"> <li>The slewing zone with load is not permitted</li> </ul>	<ul style="list-style-type: none"> <li>Slew to permitted area</li> </ul>
<b>E04</b>	Operating mode not acknowledged or non permitted slewing zone	<ul style="list-style-type: none"> <li>An incorrect operating mode has been selected</li> <li>The boom is in a non-permitted slewing zone</li> </ul>	<ul style="list-style-type: none"> <li>Set the correct operating mode for the operating configuration in question. Refer to Operator's Handbook.</li> <li>Slew the boom to a permitted area. Refer to Section 8.</li> </ul>
<b>E05</b>	Prohibited length range	<ul style="list-style-type: none"> <li>Boom has been extended either too far or not far enough, e.g. if it is prohibited to go beyond a certain maximum boom length or with load curves for jibs where the main boom has to be extended to a certain length</li> <li>Length sensor adjustment has changed, e.g. the cable slid off the length sensor reel.</li> </ul>	<ul style="list-style-type: none"> <li>Extend/retract boom to the correct length</li> <li>Retract boom. Check the prestress of the cable reel (cable must be taut). Open the length sensor and carefully turn the length sensor pot counterclockwise until the detent by means of a screw driver</li> </ul>
		<ul style="list-style-type: none"> <li>Clutch between length sensor pot and drive is defective</li> </ul>	<ul style="list-style-type: none"> <li>Replace the complete clutch including drive wheel and adjust length sensor pot as described above</li> </ul>

Error Code	Error	Possible Cause	Elimination
E11	Fallen below lower limit value for measuring channel "length main boom"	<ul style="list-style-type: none"> <li>Length potentiometer is defective</li> </ul>	<ul style="list-style-type: none"> <li>Replace length potentiometer, see section <a href="#">Length Sensing</a></li> </ul>
E12	Fallen below the lower limit value in the measuring channel "pressure piston side"	<ul style="list-style-type: none"> <li>Pressure transducer is defective.</li> </ul>	<ul style="list-style-type: none"> <li>Replace pressure transducer, see section <a href="#">Pressure Sensing</a></li> </ul>
E13	Fallen below lower limit value in the measuring channel "pressure rod side"	<ul style="list-style-type: none"> <li>refer to E12</li> </ul>	<ul style="list-style-type: none"> <li>refer to E12</li> </ul>
E14	Fallen below lower limit value in measuring channel "force"	<ul style="list-style-type: none"> <li>Force transducer defective</li> </ul>	<ul style="list-style-type: none"> <li>Replace force transducer</li> <li>Replace sensor unit</li> </ul>
E15	Fallen below lower limit value in measuring channel "angle main boom"	<ul style="list-style-type: none"> <li>Angle potentiometer defective</li> </ul>	<ul style="list-style-type: none"> <li>Replace angle sensor, see section <a href="#">Angle Sensing</a></li> </ul>
E16	Fallen below lower limit value in measuring channel "angle 2"	<ul style="list-style-type: none"> <li>Angle potentiometer defective</li> </ul>	<ul style="list-style-type: none"> <li>Refer to E-15</li> </ul>
E17	Fallen below lower limit value "length telescope I (+II)"	<ul style="list-style-type: none"> <li>Length potentiometer defective</li> </ul>	<ul style="list-style-type: none"> <li>Replace length sensor, see section <a href="#">Length Sensing</a></li> </ul>
E1A	Fallen below lower limit value in measuring channel "slewing angle 1".	<ul style="list-style-type: none"> <li>Cable between the console and the slewing angle sensor defective or loose.</li> <li>Slewing angle potentiometer is defective</li> </ul>	<ul style="list-style-type: none"> <li>Check cable as well as plugs, replace, if need be.</li> <li>Replace slewing angle sensor</li> </ul>
E1B	Fallen below lower limit value in measuring channel "slewing angle 2"	<ul style="list-style-type: none"> <li>refer to E1A</li> </ul>	<ul style="list-style-type: none"> <li>refer to E1A</li> </ul>
E21	Upper limit value in measuring channel "main boom length" has been exceeded.	<ul style="list-style-type: none"> <li>refer to E11</li> </ul>	<ul style="list-style-type: none"> <li>refer to E11</li> </ul>

<b>Error Code</b>	<b>Error</b>	<b>Possible Cause</b>	<b>Elimination</b>
<b>E22</b>	Upper limit value in measuring channel "pressure piston side" has been exceeded	<ul style="list-style-type: none"> <li>refer to E12</li> </ul>	<ul style="list-style-type: none"> <li>refer to E12</li> </ul>
<b>E23</b>	Upper limit value in measuring channel "pressure rod side" has been exceeded.	<ul style="list-style-type: none"> <li>refer to E12</li> </ul>	<ul style="list-style-type: none"> <li>refer to E12</li> </ul>
<b>E24</b>	Upper limit value in measuring channel "force" has been exceeded.	<ul style="list-style-type: none"> <li>refer to E14</li> </ul>	<ul style="list-style-type: none"> <li>refer to E14</li> </ul>
<b>E25</b>	Upper limit value in measuring channel "main boom angle" has been exceeded.	<ul style="list-style-type: none"> <li>refer to E15</li> </ul>	<ul style="list-style-type: none"> <li>refer to E15</li> </ul>
<b>E26</b>	Upper limit value in measuring channel "angle 2" has been exceeded.	<ul style="list-style-type: none"> <li>refer to E16</li> </ul>	<ul style="list-style-type: none"> <li>refer to E16</li> </ul>
<b>E27</b>	Upper limit value in measuring channel "length telescope I (+II) has been exceeded.	<ul style="list-style-type: none"> <li>refer to E17</li> </ul>	<ul style="list-style-type: none"> <li>refer to E17</li> </ul>
<b>E2A</b>	Upper limit value in measuring channel "slewing angle 1" has been exceeded	<ul style="list-style-type: none"> <li>refer to E1A</li> </ul>	<ul style="list-style-type: none"> <li>refer to E1A</li> </ul>
<b>E2B</b>	Upper limit value in measuring channel "slewing angle 2" has been exceeded	<ul style="list-style-type: none"> <li>refer to E1A</li> </ul>	<ul style="list-style-type: none"> <li>refer to E1A</li> </ul>
<b>E31</b>	Error in the system program	<ul style="list-style-type: none"> <li>The system program file is defective.</li> <li>Flash-EPROM defective</li> </ul>	<ul style="list-style-type: none"> <li>Upload valid system software</li> <li>Replace central unit</li> </ul>
<b>E37</b>	Error in the logical program flow	<ul style="list-style-type: none"> <li>System program file is defective</li> <li>Flash-EPROM defective</li> </ul>	<ul style="list-style-type: none"> <li>Upload valid system software</li> <li>Replace console</li> </ul>
<b>E38</b>	System program and crane data file do not match.	<ul style="list-style-type: none"> <li>The system program in the LMI does not match to the programming in the crane data file</li> </ul>	<ul style="list-style-type: none"> <li>Upload valid system program file or the valid crane data file</li> </ul>
<b>E39</b>	System program and load chart file do not match	<ul style="list-style-type: none"> <li>The system program in the LMI and the programming in the load chart file do not match.</li> </ul>	<ul style="list-style-type: none"> <li>Upload valid system program file or the valid load chart file</li> </ul>



Error Code	Error	Possible Cause	Elimination
E43	Error in the write/read memory, (RAM)	<ul style="list-style-type: none"> <li>Write/read memory (RAM) or console defective.</li> </ul>	<ul style="list-style-type: none"> <li>Replace console</li> </ul>
E47	<p>Error in the monitored write/read memory.</p> <p>The CRC verification of the monitored write/read memory provides an incoherent result</p>	<ul style="list-style-type: none"> <li>The CRC sign of the monitored write/read memory is wrong</li> <li>The buffer battery is discharged (&lt; 2V at 1kOhm).</li> <li>Console defective.</li> </ul>	<ul style="list-style-type: none"> <li>Restart the LMI</li> <li>Replace main board in the console.</li> <li>Replace console</li> </ul>
E51	Error in the crane data file	<ul style="list-style-type: none"> <li>No valid data in the crane data file.</li> <li>Flash-EPROM defective</li> </ul>	<ul style="list-style-type: none"> <li>Upload valid crane data file</li> <li>Replace console</li> </ul>
E52	Error in load chart file.	<ul style="list-style-type: none"> <li>No valid data in the load chart file</li> <li>Flash-EPROM defective</li> </ul>	<ul style="list-style-type: none"> <li>Upload valid load chart file</li> <li>Replace console</li> </ul>
E56	Error in crane data file.	<ul style="list-style-type: none"> <li>No valid data in the crane data file during calibration.</li> <li>Flash-EPROM defective</li> </ul>	<ul style="list-style-type: none"> <li>Restore or upload valid crane data file</li> <li>Replace console</li> </ul>
E57	Error in serial crane data file.	<ul style="list-style-type: none"> <li>Calibration data file does not contain valid data.</li> <li>Flash-EPROM defective</li> </ul>	<ul style="list-style-type: none"> <li>Upload calibration data file</li> <li>Replace central unit</li> </ul>
E60	The number of the selected File base and the programmed value are not identical	<ul style="list-style-type: none"> <li>No valid data in the load chart file</li> <li>Base number not programmed</li> <li>Load chart file wrongly programmed</li> </ul>	<ul style="list-style-type: none"> <li>Upload valid load chart file</li> <li>Program the correct base number (1 for base 1, 2 for base 2)</li> <li>Check base programming in the load chart file.</li> </ul>
E61	Error in the CAN bus data transfer for all CAN units	<ul style="list-style-type: none"> <li>CAN Bus cable between the central unit and the sensor units defective or not connected.</li> <li>Short circuit in a CAN Bus cable</li> </ul>	<ul style="list-style-type: none"> <li>Check the connection between the central unit and the sensor units (wiring harness). See section <a href="#">CAN-Bus Communication</a></li> <li>Replace Can Bus cable</li> </ul>

Error Code	Error	Possible Cause	Elimination
		<ul style="list-style-type: none"> <li>• Can bus port in the central unit defective</li> </ul>	<ul style="list-style-type: none"> <li>• Replace the console</li> </ul>
		<ul style="list-style-type: none"> <li>• Blown fuse in console</li> </ul>	<ul style="list-style-type: none"> <li>• Replace 2 amp fuse</li> </ul>
<b>E62</b>	Error in the can bus data transfer of the pressure transducer sensor unit	<ul style="list-style-type: none"> <li>• Cable between the console and the sensor unit defective or not connected.</li> </ul>	<ul style="list-style-type: none"> <li>• Check the cable to the sensor unit (wiring). See section <a href="#">CAN-Bus Communication</a></li> </ul>
		<ul style="list-style-type: none"> <li>• Blown fuse in console</li> <li>• Sensor unit is defective</li> </ul>	<ul style="list-style-type: none"> <li>• Replace 2 amp fuse</li> <li>• Replace the sensor unit</li> </ul>
<b>E63</b>	Error in the can bus pressure transducer sensor unit	<ul style="list-style-type: none"> <li>• The analog values of the sensor unit are invalid</li> </ul>	<ul style="list-style-type: none"> <li>• Replace the sensor unit See section <a href="#">CAN-Bus Communication</a>.</li> </ul>
<b>E64</b>	Error in the can bus data transfer of the length/angle sensor unit	<ul style="list-style-type: none"> <li>• Cable between the pressure transducer and cable reel defective or not connected.</li> <li>• Sensor unit is defective</li> </ul>	<ul style="list-style-type: none"> <li>• Check the cable to the sensor unit. See section <a href="#">CAN-Bus Communication</a></li> <li>• Replace the electronic board in the cable reel, see section <a href="#">CAN-Bus Communication</a></li> </ul>
<b>E65</b>	Error in the can bus length/angle sensor unit	<ul style="list-style-type: none"> <li>• Angle sensor defective</li> <li>• Length sensor defective</li> <li>• Sensor unit is defective</li> </ul>	<ul style="list-style-type: none"> <li>• Replace the angle sensor, see section <a href="#">CAN-Bus Communication</a></li> <li>• Replace the length sensor, see section <a href="#">CAN-Bus Communication</a></li> <li>• Replace the electronic board in the cable reel, see section <a href="#">CAN-Bus Communication</a></li> </ul>
<b>E66</b>	Error in the can bus data transfer of the 2 <sup>nd</sup> length/angle sensor unit	<ul style="list-style-type: none"> <li>• See E62</li> </ul>	<ul style="list-style-type: none"> <li>• See E62</li> </ul>
<b>E67</b>	Error in the can bus of the 2 <sup>nd</sup> length /angle sensor unit	<ul style="list-style-type: none"> <li>• See E63</li> </ul>	<ul style="list-style-type: none"> <li>• See E63</li> </ul>
<b>E68</b>	Error in the can bus data transfer of the force sensor unit	<ul style="list-style-type: none"> <li>• See E62</li> </ul>	<ul style="list-style-type: none"> <li>• See E62</li> </ul>
<b>E69</b>	Error in the can bus force sensor unit	<ul style="list-style-type: none"> <li>• See E63</li> </ul>	<ul style="list-style-type: none"> <li>• See E63</li> </ul>
<b>E80</b>	Error in the slewing angle measurement	<ul style="list-style-type: none"> <li>• The difference between the average of the slewing angle and one of the wipers of the slewing potentiometer is out of the tolerance</li> </ul>	<ul style="list-style-type: none"> <li>• See section <a href="#">Slewing Sensing</a></li> </ul>

<b>Error Code</b>	<b>Error</b>	<b>Possible Cause</b>	<b>Elimination</b>
<b>E84</b>	Wrong rigging condition.	<ul style="list-style-type: none"> <li>The selected rigging condition is not contained in the crane data file.</li> </ul>	<ul style="list-style-type: none"> <li>Select another rigging condition</li> <li>Check the programming in the crane data file.</li> </ul>
<b>E85</b>	Error in the radius determination	<ul style="list-style-type: none"> <li>The computed radius is too small (negative deflection)</li> </ul>	<ul style="list-style-type: none"> <li>Check the programming in the crane data file.</li> </ul>
<b>E89</b>	Operating mode switchover with load.	<ul style="list-style-type: none"> <li>The operating mode on the console has been switched over with the boom loaded.</li> </ul>	<ul style="list-style-type: none"> <li>Select operating mode without load on the boom</li> </ul>
<b>EAB</b>	Short circuit in the A2B switch circuit	<ul style="list-style-type: none"> <li>Short circuit in the A2B switch</li> <li>Short circuit in the cable to the A2B switch</li> </ul>	<ul style="list-style-type: none"> <li>Replace A2B switch</li> <li>Replace cable to the A2B switch</li> </ul>
<b>EAC</b>	A2B switch circuit disconnected	<ul style="list-style-type: none"> <li>Disconnected cable in the A2B switch</li> <li>Disconnected cable to the A2B switch</li> </ul>	<ul style="list-style-type: none"> <li>Connect or replace cable in the A2B switch</li> <li>Connect or replace cable to the A2B switch</li> </ul>
<b>EAD</b>	No valid A2B switch status	<ul style="list-style-type: none"> <li>Sensor wrong function</li> <li>CAN bus delay</li> </ul>	<ul style="list-style-type: none"> <li>Replace A2B switch</li> <li>Replace cable to the A2B switch</li> </ul>

**Note:**

If an error message is displayed which is not contained in above list, please contact the HIRSCHMANN service department.

## 15 TROUBLESHOOTING MOISTURE

The Hirschmann Mentor contains electronic components in various locations, such as console, sensors, junction boxes etc. These internal components cannot be designed to withstand exposure to moisture over a longer period of time. For this reason, the housings of the components are water protected according to IP 65. If you find water or moisture inside any of the housings, the source for the water ingress has to be detected and corrected to ensure proper operation.

There are two major possibilities for the occurrence of excessive moisture inside an enclosure:

- 1) Water ingress
- 2) Condensation

This outline gives instructions for detecting the cause for excessive moisture by using simple troubleshooting methods and how to prevent the moisture ingress from happening again.

### 1. WATER INGRESS

There are 6 possibilities for water to enter an enclosure:

- 1) Spray Cleaning
- 2) Missing / Loose Screws
- 3) Bent Lid
- 4) Defective Gasket
- 5) Loose Strain Relieves
- 6) Water Entry Through External Cabling

It is possible to find out the source of water ingress by going through the following steps and ruling out one possibility after the other until the cause is identified:

#### 1) Spray Cleaning

The enclosures used for the LMI system are water protected to IP 65. This means protection against the environment, such as rain. However, through the use of spray cleaner at short distances, it is possible to force water through the gasket or strain relieves. For this reason, avoid spraying any components from short distances with spray cleaners. Convey this fact to any member of a maintenance crew.

#### 2) Missing / Loose Screws

All screws have to be present and to be equally tight to ensure water protection of the enclosure. If there are screws missing, replace them. If no screw is missing, check the tightness. If any were loose, then open all screws and then re-tighten them equally.

#### 3) Bent Lid

An enclosure will only seal correctly if the lid is not bent. To check this, loosen all screws of the lid, take the lid off the box and visually inspect it for deflection. If the lid is bent or damaged, it needs to be replaced. Try to determine what has caused the lid to be bent and eliminate the reason for that. Order a new lid through your Hirschmann representative.

---

#### 4) Defective Gasket

The gasket underneath the lid seals the unit. The gasket needs to be in good condition in order to seal correctly. If the gasket is torn, brittle or severely bent, it needs to be replaced. Order a new gasket through your Hirschmann representative.

#### 5) Loose Strain Relieves

The strain relieves allow cabling to enter the box without allowing water to enter it. The strain relieves have to be correctly tightened in order to do this. Check the tightness by taking the external cable into one hand and carefully trying to turn it. If the internal wires turn with the outer cable, the strain relief is loose. Get a new grommet (insert) through your Hirschmann representative and replace the existing one with the new one. Tighten the strain relief correctly. Note: Whenever a strain relief is opened, i.e. to replace a cable, a new grommet needs to be used. Never re-use any grommet or the strain relief will not seal properly!

#### 6) Water Entry Through External Cabling

Even with a tight strain relief, water may still enter the box through the inside of the cable. In this case, you have to find out why and where water enters the cable. Look for damages to the cable itself and inspect the opposite side of the cable. In example, if the cable comes from a connector that is full of water, the water will run through the inside of the cable and fill up the central unit, too.

## 2. CONDENSATION

In a climate with high humidity and rapidly changing temperatures, condensation can happen inside any enclosure, usually the larger the volume of the box, the more likely. In this case, water drops build up on the inner components when humid air is trapped inside the box. With condensation, water tightness is not a problem – the box is sealed just fine, which is what prevents the trapped air from exiting the box. There are two ways to deal with condensation:

1. If the volume is very small, a desiccant bag might be able to soak up the air's humidity.
2. If the effect is more severe, the only way to get rid of this effect is then to give the box the ability to breath without sacrificing its water tightness. Contact your Hirschmann representative for breathing elements to than can be added to the box and will help to reduce the effects of humid climates.